



# **HUCK** *Bird Control*

Professional Bird Proofing & Flying Insect Control Systems

 [www.huck-net.co.uk](http://www.huck-net.co.uk) | +44(0)1308 425100

# HUCK *Bird Control*

Gore Cross Business Park, Corbin Way, Bradpole, Bridport, Dorset DT6 3UX

## Contents

### PROFESSIONAL BIRD CONTROL PRODUCTS

Bird School Training & Support	4
Bird Proofing Strategy	5
Bird Proof Netting	8
Stock Nets	9
Gull Netting	10
Knotless Netting	11
Installations	12
Net Fixing	14
Roof Mount	23
Spike Systems	24
Chimney Spikes	28
Post & Wire Systems	29
Scare Gull, Bird Scare, Daddi Long Legs	35
Audible Systems	36
Bird Free Gel	37
Weld mesh, Permanet	38
Brush Solutions	40
Prickler	41
Custom Metal Work	41
Aviary Netting	42
Personal Protection Equipment & Tools	44
Types of Netting in stock	47
Useful Measurement Conversions	47

### FLYING INSECT CONTROL SYSTEMS

Translucent Technology	48
Genus Cobra	49
Genus Optica	50
Genus Liberator	51
Genus Viper	52
Genus Spectra	53
Genus Elipse	54
Genus Illume	55
Bed Bug Monitoring Systems	56

TERMS & CONDITIONS	57
--------------------	----

HISTORY	58
---------	----



## Bird Control

### Company Terms & Conditions

#### Payment Terms:

UK SALES - Nett monthly terms (subject to satisfactory references). Payment due 30 days following the date of invoice. The ownership of the goods will only be transferred to the purchaser when payment is made in full to Huck Nets (UK) Ltd.

**Quantity Discounts:** We will be pleased to quote for larger quantities than those indicated in the catalogue.

**Accounts:** All accounts will be held with Huck Nets (UK) Ltd., Bridport, Dorset.

**Cheques Not Honoured:** Cheques which are returned by the bank and have to be represented will be charged to the customers account at £10.00 per transaction.

### Carriage Charges

**Carriage Paid:** Orders above £250 nett are carriage paid on our 24hr delivery service. Under the value of £250 nett will be charged at £8.99

**Standard Delivery Service:** 24 hour (1 working day excluding Saturday).

Small jiffy bags: by Post minimum charge £3.95

Large Parcels: by 24 hour Carrier will be charged at cost subject to a minimum charge of £8.99

Some parts of Scotland have a 48 hour delivery service.

**Express Delivery Service:** On request we will quote for next day 10am, 12am and Saturday delivery.

**Export Orders:** Carriage on ALL export orders will be charged at cost.

Errors and omissions excepted

# Welcome to Huck Bird Control - The home of Professional Bird Proofing products and flying insect control systems...

This catalogue is brought to you by Huck Bird Control. A strategic partnership between Huck Nets UK, leading manufacturers and suppliers of netting products and Brandenburg Direct, innovators in environmental improvement products.

Now in our Fourth year, Huck Bird Control successfully continues to supply the World's leading Pest management and Bird Proofing companies, and remains the first choice in quality and cost.

We are experts in what we do. Whether you would like us to manage and implement an effective Bird Proofing solution, or deliver a complete and comprehensive range of products for international distribution, our dedicated team is always on hand to assist and provide you with all the information you may require.

**Call Today on: +44(0)1308 425100**



Dave Collins  
Technical Sales Manager  
dave.collins@hucknetting.co.uk  
Mobile: +44 (0)7980 644042



Andrew Coates  
Sales Manager  
andrewcoates@b-one.com  
Mobile: +44 (0)7792 069015



Jon Legg-Bagg  
Managing Director  
jon@hucknetting.co.uk



Matt Thomas  
Bird Sales  
matt.thomas@hucknetting.co.uk

## Bird Control Orders

All stock item orders made before 12 noon are dispatched the same day as the order is received. We use next day carriers for all our deliveries. All orders from the UK under the value of £250 will be charged at £8.99. Orders over the value of £250 are dispatched carriage paid unless you have asked for a specified delivery time (these are charged separately and will be quoted at the time of placing the order). 8ft x 4ft Weldmesh panels incur a £20.00 surcharge.

## Custom Metal Work

As well as supplying bird netting to meet your exact size and requirement we now have our own custom metal workshop in Sheffield. Call for Dave Collins 01308 425100 for information.

## Site Selection & Surveying

Whatever the size of project we will help you select the right bird proofing solution. We will also undertake onsite surveys to ensure you order the right size netting and the correct bird proof protection for the site. Please contact Dave Collins 01308 425100 email dave.collins@hucknetting.co.uk

# Bird School Training and Support

Huck Bird Control is pleased to announce their new world class - Bird School. Established to provide businesses and individuals with a fuller understanding of the subject of bird control, with practical hands on demonstrations, and assessments.

Our standard two day course is ideal for beginners through to intermediates. Bespoke advanced training can be arranged with prior notice - including intensive training in any area of bird control including Rope Access.

Our courses can be taken at Huck Bird Control's Head Office in Bridport, or even at your own business premises.

## Intensive Two Day - Theory & Practical

### Course Content:

This course expands upon all aspects of bird control. Ideal for beginner - intermediate levels

#### Introduction to Bird Control

#### Proofing Techniques Theory & Practical

Netting  
Spikes  
Bird wire  
Bird gel  
Bird shock

#### Surveying & design

#### Safety in Bird Control

#### Practical Assessments in real life environments

Brick/Concrete/Wood

#### Final Test

#### Certificate Presentation

*Training to gain all the information you need to put in place  
An effective bird control strategy*



For more information, please call  
Dave Collins on 01308 426 785



## Got an Urban Pest Problem?

### Bird Species

To solve bird problems effectively, you must know the species that is causing the problem so you can select the correct bird control solution. Listed below are the most common species of pest birds and the control products you should use to humanely resolve the problem.

#### Feral Pigeon

(*Columba livia*) 33cm long

The most common urban pest bird worldwide. Descended from medieval domestic pigeons, this mixed wild population lives freely in towns and cities causing widespread fouling of buildings and transmits bird diseases to humans.



#### Herring Gull

(*Larus argentatus*) 55cm long

A large aggressive bird with a powerful beak. They cause significant problems by colonising buildings and bringing noise, mess and smell to these urban breeding sites. Adult birds are known to attack anyone they feel is a threat to their nest. It is, therefore, considered prudent to install proofing against gulls before nesting begins in April. Audible scare tactics have met some short term success.



#### Starling

(*Sturnus vulgaris*) 20cm long

The familiar town bird can cause problems when large numbers [1000s] gather for night roosting. Such gatherings are accompanied by noise and smell. The fungi associated with extensive quantities of droppings due to these gatherings can cause human disease. Distress call recordings can be used with some success to prevent night roosting.



#### House Sparrow

(*Passer domesticus*) 14.5cm long

These best known of city birds are known to cause major problems to the food industry when they populate warehouses and retail premises resulting in damage and fouling of stored food. Their agility and small size make these birds difficult to control. These birds have no known distress call.



# Huck Bird Control Have the Answer

## Bird Proofing Strategy

Once you have identified the bird species you must get to know their behaviour and habits before you can put together an effective bird proofing strategy. How the birds use a particular site is known as Bird Pressure.

## Bird Pressure

### Heavy Pressure:

The bird is nesting or roosting at this site and there is generally a food or water source nearby. Heavy pressure sites can only be successfully proofed using well-installed Huck bird netting or weld mesh systems. Where netting cannot be installed the heavy duty PinPoint systems or ValuePoint may be successful but some persistent resident birds might need to be culled.

### Medium Pressure:

This is not a nesting or roosting site but it most likely an area for food or afternoon resting. Medium pressure sites can be successfully proofed with many systems, but great care needs to be taken. Birdwire systems should only be applied with appropriate techniques by experienced installers. Bird spike systems such as Birdchain, PinPoint and ValuePoint can be used but care must be taken to ensure there are no gaps; the birds should be prevented from getting on the system before the glue has cured. If possible, superior Huck Bird Net should be used.

### Light Pressure:

Birds will stop here briefly during the day as there is no food or shelter available. Light pressure areas can be successfully proofed with virtually any type of physical proofing system suitable for the species concerned.

Bird	Pressure	Product	Page No.
All	All	Netting	8
Pigeons, Gulls, Crows	All	Spikes	24
Pigeons, Gulls	Light or Medium	Post & Wire	31
Pigeons, Gulls	Light or Medium	Bird Spider	37
Gulls	All	ScareGull	37
All	All	Audible Systems	38
Pigeons, Sparrows	Light or Medium	Bird Repellent Gel	39
All	All	Weldmesh	40
All	All	Brush Strip	42

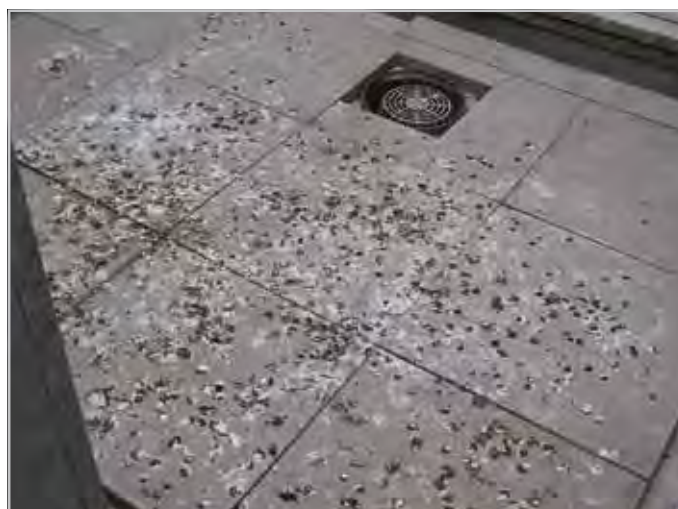

Once you know the species of bird you are dealing with and you know the nature of the infestation you are then in a position to select the appropriate bird proofing solution to ensure that the birds do not return to the site.

**The detail in this catalogue aims to give you the necessary information you need to have an effective proofing strategy. However, if you are having difficulty and would like some assistance please call 01308 425100. We are pleased to help.**

# Huck Bird Control Have the Answer

## Products

### Bird Netting [page 8]

Bird netting is one of the most popular methods used for excluding pest birds from all types of objects, openings and structures. As one net can be used to protect many perching places, bird netting is often the most cost effective solution.

Unlike any other supplier, we manufacture and supply a choice of netting including traditional 12/6 knotted netting and our unique 'knotless' netting. Huck Nets has been making nets for over 40 years and pioneered the manufacture of high quality knotless netting.

#### Why consider knotless netting?

- Knotless netting is produced in a square pattern so it stays in shape after installation.
- According to The New Journal of Physics knotless netting is 60% stronger, like for like, than knotted netting.
- Knotless netting feels softer on the hands and therefore is easier to install.
- Knotless netting could easily be seen as a better product but is still competitively priced.

**Whatever your choice, Huck Bird Control supply both knotted and knotless nets, cut to size, on an overnight service.**

### Bird-Scape® [page 13]

Bird-Scape is an ingenious device that eliminates the risk of large or small birds being trapped behind netting. Birds often hide away out of sight while the netting is being installed only to reappear trapped when the job is finished causing much public concern. The aptly named Bird Scape provides a one way escape route for birds. Birds can fly out through the Bird-Scape unable to return.

### Huck Spike Systems [page 24]

*For pigeons, gulls and crows.* All pressures.

Huck offer a wide selection of spike designs and styles for use on ledges, signs, ridges, beams, pipes, parapets etc. Spike systems are very effective against pigeons but are not recommended for sparrows or starlings. Special spike systems are available for gulls.

### Huck Post & Wire Systems [page 31]

*For pigeons and gulls.* Light or medium pressure.

A light duty system of spring loaded wires supported between stainless steel posts for use on ledges, signs, sills, parapets,

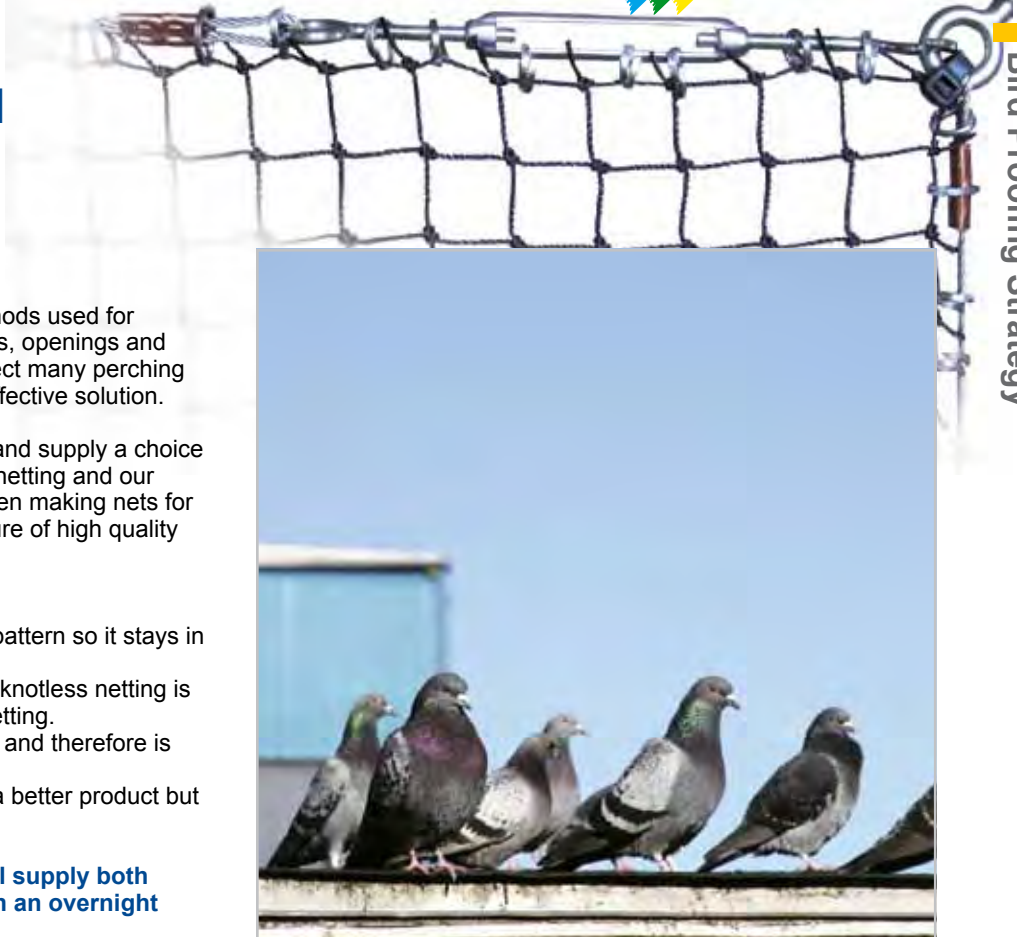

beams, pipes, etc. Use against pigeons and gulls and where low visual impact is required. This system is not effective against starling or sparrow.

### Electric Bird Deterrent [page 36]

New range coming soon, call for details

### ScareGull [Page 37]

*Gulls.* A purposely designed and proven gull deterrent.

### Audible Systems [page 38]

*For all birds.* An exciting range of 'friendly' bird scaring products that combine sight, sound and fear to provide you with the variety required for an effective bird control strategy.

### Bird Free Gel [page 39]

*For all birds.* A long lasting deterrent that is quick and easy to apply. Keeps all birds off all structures. It does so by altering their behaviour, not by acting as a physical barrier. Birds will completely desert a habitat, even one they have been using for years, once Bird Free has been applied.

### Weldmesh [page 40]

*For all birds and all pressures.* Like netting, Weldmesh is an effective barrier against birds that are nesting at night. It is the solution for areas where it is difficult to attach a tensioned wire system as it can be cut to shape and size. It can also be bent to fit.

## Don't forget!

**When proofing is installed the birds will try to overcome it. How determined they are will depend upon the bird pressure. When they find that they cannot overcome it, they will often look for alternative areas nearby; this could also include small ledges which they would not normally use. It is therefore wise, to avoid expensive call-backs, to anticipate what might happen and to put in additional bird proofing**



# Bird Proof Netting

## A cost effective solution to URBAN PEST BIRD PROBLEMS

A correctly installed net, whether used vertically or horizontally, and on virtually any part of a building, can solve almost all bird problems

### Polyethylene (Polythene) Net

A traditionally knotted 12/6 polyethylene square mesh netting which is UV stabilised to give a life expectancy of 10 years or more in normal use. Chemically inert and rot proof, the breaking strain of 12/6 twine is approximately 20kg and is available in black, stone or translucent. 75mm square mesh netting is made using 12/6 twine for additional strength. Available in Black & Translucent. Flame free netting contains a coloured fleck to make it easily identifiable.

Cat No.	Description	Pack
BN2062	19mm (3/4") 12/6 Translucent	m <sup>2</sup>
BN2063	50mm (2") 12/6 Translucent	m <sup>2</sup>
BN2071	19mm (3/4") 12/6 Black	m <sup>2</sup>
BN2072	28mm (1 1/8") 12/6 Black	m <sup>2</sup>
BN2074	50mm (2") 12/6 Black	m <sup>2</sup>
BN2077	19mm (3/4") Flame Free Black	m <sup>2</sup>
BN2078	50mm (2") Flame Free Black	m <sup>2</sup>
BN2101	19mm (3/4") 12/6 Stone	m <sup>2</sup>
BN2102	28mm (1 1/8") 12/6 Stone	m <sup>2</sup>
BN2104	50mm (2") 12/6 Stone	m <sup>2</sup>



Black

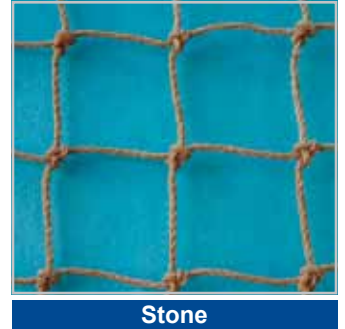

Stone

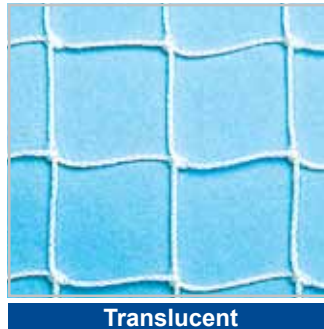

Translucent



Flame Free

All nets are supplied cut to size and ready to fit. All four corners and longer sides are marked for ease of handling on site. Order any size you like - we will produce the nets to your requirements.



### Polyethylene bird netting weight information

There are approximately 14sq metres in 1kg of 19mm 12/6 netting therefore a 20m x 20m net will weigh 28kg. The following table shows similar formulae for other mesh sizes.

Mesh Size	Bird Protection	Coverage per Kg	Weight per m <sup>2</sup>
19mm 12/6	Sparrow	14sqm	71g - (0.071kg)
28mm 12/6	Starling	24sqm	42g - (0.042kg)
50mm 12/6	Pigeon	47sqm	22g - (0.022kg)
75mm 10/9	Herring Gull	60sqm	17g - (0.017kg)



# Bird Proof Netting

## Stock Nets

Normally ready for immediate same day despatch if ordered before 12 noon.

Cat No.	19mm mesh colour Black	Pack
BN2087	5m x5m	Each
BN2085	10m x 5m	Each
BN2083	10mx10m	Each
BN2084	20m x 5m	Each
BN2082	20m x 10m	Each
BN2081	20mx20m	Each
Cat No.	19mm mesh colour Stone	Pack
BN2123	10mx10m	Each
BN2122	20m x 10m	Each
BN2121	20m x 20m	Each
Cat No.	28mm mesh colour black	Pack
BN2093	10m x10m	Each
BN2091	20m x10m	Each
Cat No.	50mm mesh colour black	Pack
BN740505	5m x5m	Each
BN741005	10m x 5m	Each
BN2099	10mx10m	Each
BN741510	15m x10m	Each
BN741515	15m x 15m	Each
BN2098	20m x 10m	Each
BN2097	20m x 20m	Each
BN743010	30m x 10m	Each
BN743020	30m x 20m	Each
BN743030	30m x 30m	Each
Cat No.	50mm mesh colour stone	Pack
BN2129	10m x10m	Each
BN2128	20m x 10m	Each
BN2127	20m x 20m	Each



## Net Installation

Net is secured in place on a building by attaching it to tensioned wire rope which forms the boundary of the area to be netted. Main fixings for the wire are usually expanding eye bolts (beam bolts or bridge clamps in metalwork). These carry the weight of the installation and are used at the net corners and every 5 - 10m along the wire and wherever the net changes direction. Between these main fixings, intermediate fittings are used to hold the wire tight against the structure. Their centres will depend on bird species and shape of net. Typically 1m centres for pigeon or gull, 0.5m for starling and 0.3m for sparrow.

## Netting Access Heavy Duty Plastic Zips

The addition of a non corrosive zip fitted after installation makes maintenance simple. Held in place by hog rings, the zip is then undone and the mesh behind cut to access. Zip up and the job is complete. A no 9 zip suits both 19mm and 50mm netting. For 19mm cut two meshes. For 28mm use No 5 zips.

Cat No.	Description	Pack
ZIP9 1006	Zip No. 9 Black 1m	Each
ZIP9 2006	Zip No. 9 Black 2m	Each
ZIP9 0506	Zip No. 9 Black 0.5m	Each
ZIP9 1008	Zip No. 9 Stone 1m	Each
ZIP9 2008	Zip No. 9 Stone 2m	Each
ZIP9 0508	Zip No. 9 Stone 0.5m	Each
ZIP9 1002	Zip No. 9 White 1m	Each
ZIP9 2002	Zip No. 9 White 2m	Each
ZIP9 0502	Zip No. 9 White 0.5m	Each
ZIP5 6100	Zip No. 5 Black 1m	Each
ZIP5 6200	Zip No. 5 Black 2m	Each
ZIP5 6050	Zip No. 5 Black 0.5m	Each

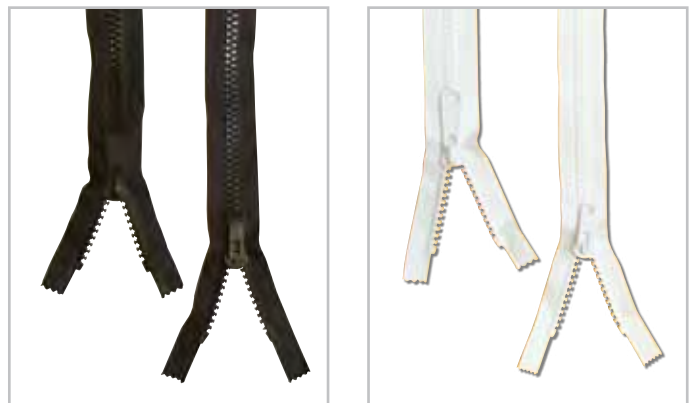

## Repair Twines and Braided Cord

12/6 twine in 150g, 250g, & 500g spools for repairs to polyethylene nets. 3mm black braided cord for supporting nets in small areas. Titanium Coated Shears have titanium coated blades for long life. Suitable for cutting thin metal sheets and wire (<0.6mm - 24 SWG). Blade Length: 60mm. Tool Length: 200mm.

Cat No.	Description	Pack
BN2139	Titanium Coated Shears	Each
BN2148	3mm Braided Cord Black	1000g
BN2150	12/6 Twine Stone or Translucent	150g
BN2151	12/6 Twine Black	250g
BN2152	12/6 Twine Black	500g



# Gull Netting

## Gull Netting

Knotted 12/6 black ultra-violet stabilised 75 mm square mesh and knotted translucent square mesh for use against Herring Gull, Lesser & Great Black Backed Gull. Ideal in horizontal situations. (Knotless available - 100mm + 75mm)

Cat No.	Description	Pack
BN2075	75mm Black - Knotted	m <sup>2</sup>
BN2064	75mm Translucent - Knotted	m <sup>2</sup>
203-100-06	100mm Black - Knotless	m <sup>2</sup>
203-075-06	75mm Black - Knotless	m <sup>2</sup>



BN2075 - 75mm (3") Knotted Gull Net



203-075-06 - 75mm (3") Knotless Gull Net



See page 16 for 3 mm 7 x 7 straining wire.



## Ersatz Egg - Imitation Egg

Research shows that replacing seagull eggs with plastic imitations in the nest reduces breeding success and keeps gulls calm during the breeding season

Cat No.	Description	Pack
EE01	Ersatz Egg - imitation eggs	3

EE01

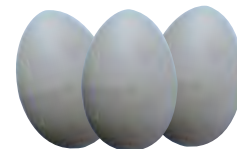

## Stainless Steel Orange Coated Wire [Gull Grid Wire]

This can be used on roofs as an alternative to gull netting; using the straining wire as above but fitting 1.2mm wires parallel to each other and with about 400mm centres. The Orange nylon coating will be more visible to the gulls and doesn't need to be tensioned. Wires can be attached to the straining wire using ferrules and ratchet crimp pliers (see page 16).

Cat No.	Description	Pack
WA2232	1.2mm 7 x 7 Stainless Steel Orange coated wire	100m

WA2232





# High Tenacity Knotless Netting

## Knotless Netting

Knotless high tenacity polypropylene. UV stabilised. Lightweight yet stronger than polyethylene nets, so useful for horizontal applications. Twine thickness 1mm. Nets are available in 50mm, 30mm or 20mm square mesh in black, stone or translucent.

Guide to codes: First 3 numbers = Twine Thickness,

Second 3 numbers = Mesh Size, Last 2 numbers = Colour

Twine Thickness	Mesh Size	Colour	Bird Protection
202 = 1mm	050 = 50mm	02 = Translucent	Mesh size 020 = Sparrows
	030 = 30mm	06 = Black	Mesh size 030 = Starling
	020 = 20mm	08 = Stone	Mesh size 050 = Pigeons
203 = 1.5mm	075 = 75mm		Mesh size 075 = Gulls
	100 = 100mm		Mesh size 100 = Gulls

Cat No.	Description	Pack
202-050-06	50mm Black Knotless Netting	m <sup>2</sup>
202-030-06	30mm Black Knotless Netting	m <sup>2</sup>
202-020-06	20mm Black Knotless Netting	m <sup>2</sup>
202-050-08	50mm Stone Knotless Netting	m <sup>2</sup>
202-030-08	30mm Stone Knotless Netting	m <sup>2</sup>
202-020-08	20mm Stone Knotless Netting	m <sup>2</sup>
202-050-02	50mm Trans Knotless Netting	m <sup>2</sup>
202-030-02	30mm Trans Knotless Netting	m <sup>2</sup>
202-020-02	20mm Trans Knotless Netting	m <sup>2</sup>



**202-050-06 Black**  
Knotless Bird Protection Net made from High Tenacity Polypropylene 1mm approx diameter, 50mm mesh



**202-050-08 Stone**  
Knotless Bird Protection Net made from High Tenacity Polypropylene 1mm approx diameter, 50mm mesh



**202-050-02 Translucent**  
Knotless Bird Protection Net made from High Tenacity Polypropylene 1mm approx diameter, 50mm mesh

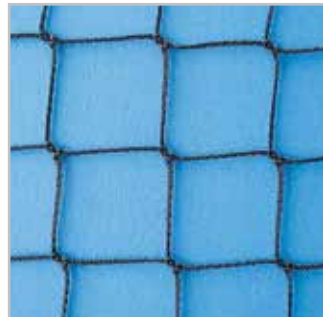

**202-030-06 Black**  
Knotless Bird Protection Net made from High Tenacity Polypropylene 1mm approx diameter, 30mm mesh



**202-030-08 Stone**  
Knotless Bird Protection Net made from High Tenacity Polypropylene 1mm approx diameter, 30mm mesh



**202-030-02 Translucent**  
Knotless Bird Protection Net made from High Tenacity Polypropylene 1mm approx diameter, 30mm mesh

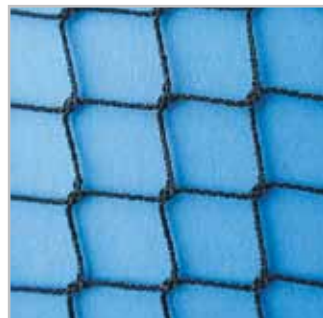

**202-020-06 Black**  
Knotless Bird Protection Net made from High Tenacity Polypropylene 1mm approx diameter, 19mm mesh

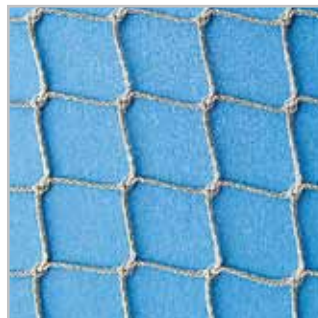

**202-020-08 Stone**  
Knotless Bird Protection Net made from High Tenacity Polypropylene 1mm approx diameter, 19mm mesh



**202-020-02 Translucent**  
Knotless Bird Protection Net made from High Tenacity Polypropylene 1mm approx diameter, 19mm mesh

**HUCK KNOTLESS NETTING** is hand cut to size by our highly skilled netting team in our own factory. We can therefore cut to any size and to most shapes to meet your individual requirements. We also have installation services available too. Call 01308 425100 for a quote.



## Selection of Installations Using Our Netting

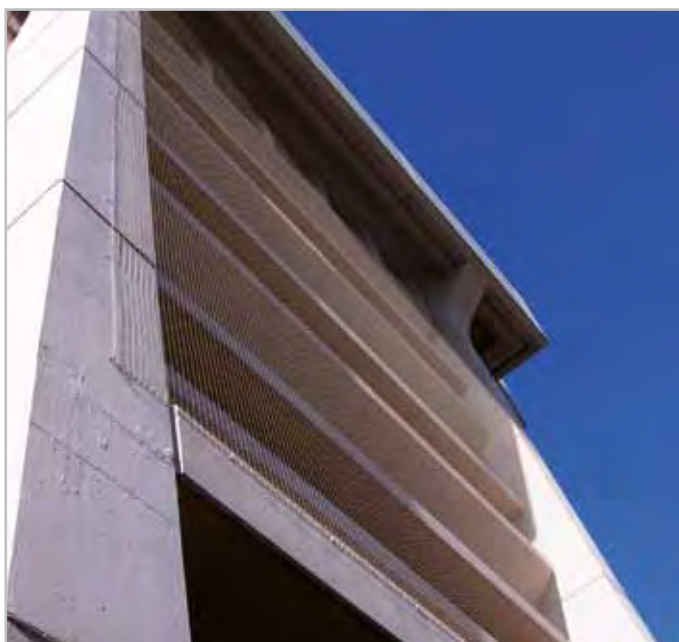
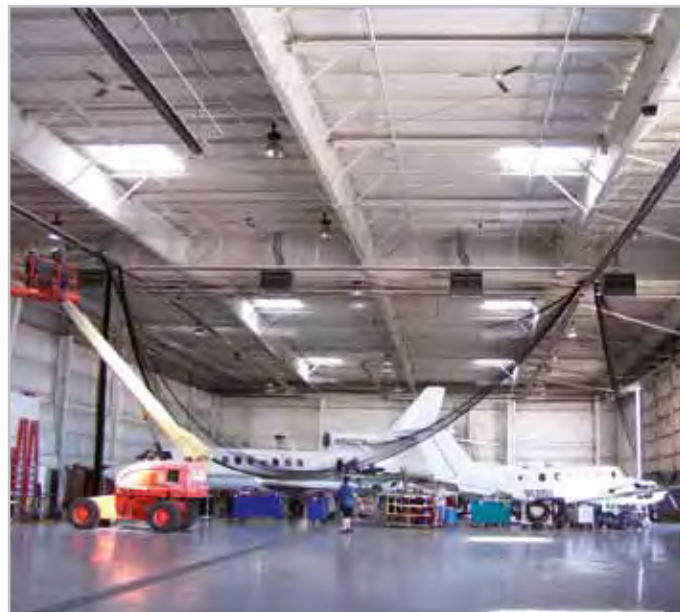

*Huck knotless netting installations*



*Primark - installed by Beaver Pest Control, London*



*Installed by Graham Pest Control*



*Horse Guard Parade - installed by Beaver Pest Control, London*

## Bird-Scape®

The innovative Bird-Scape® is the answer to the age old problem of bird proofing

We all know birds often hide away while netting is being installed only to re-emerge when the work is complete.

The Bird-Scape is an effective one-way escape route for birds of any size. It can be installed within minutes using standard hog ring pliers into vertical or horizontal netting. Birds will fly out through the Bird-Scape but will not be able to get back. At least one Bird-Scape should be put into every net you install to give you total peace of mind.

**BIRD-SCAPE IS VERY EASY TO INSTALL. ALL YOU NEED IS HOG RING PLIERS AND AT LEAST SIX HOG RINGS**  
[see page 14]

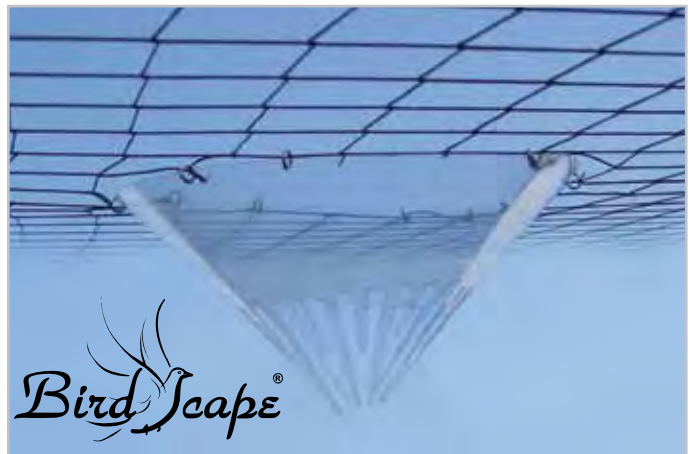

Cat No.	Description	Pack
BN2050	Bird-Scape	5



# Net Fixing

Installing a net needs planning. You not only need to ensure that you have the right size of mesh for the bird species you are proofing against but that you have the right fixings to enable you to attach the net successfully to the masonry, timber, steelwork or cladding periphery and also make it as unobtrusive as possible.

A wide range of variety of fixings can be used. The majority are available in galvanised or stainless steel. The stainless steel is either 304 or 316 marine grade, and is a superior product. Galvanised material can start to corrode soon after installation and should only be used when the proofing budget will not allow for the superior stainless steel material.

### Installation of a basic pigeon net (50mm / 2''):

To fix straining wire all the way around the edge of the area to be netted, drill holes and fit main fixings where the net will turn a corner or after a straight run of 10m. Attach the wire rope to a main corner fixing by using a hook and wire and fix it with either a wire rope grip or crimped ferrules. Run up to 10m of wire through the fixings and tension using a barrel strainer hooked into another main fixing. Tensioned cross wires should be installed where appropriate. To install the net attach one corner of the net to the corner main fixing using the net corner tie. Hog ring the mesh to the wire rope ensuring that net is pulled tight. You will need to install corner fixings every 10m to spread the weight of the net. You may also need to install additional cross wires.

If you require help with installation please call Dave Collins on 01308 425100

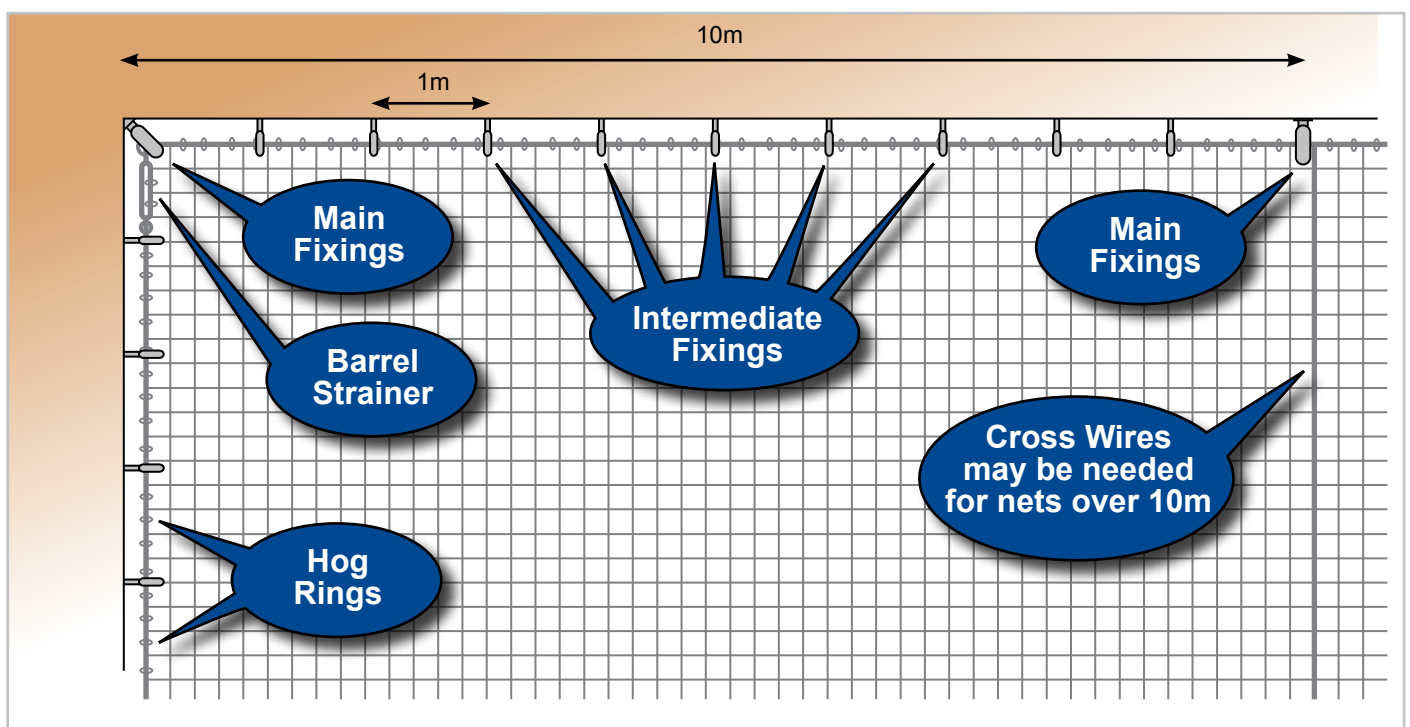





# Net Fixing

## Net Straining Wire

The netting is attached to the straining wire using hog rings (ideally in every mesh of the net). These are applied using P7

Cat No.	Description	Pack
WA2233	1.5mm 7 x 7 Galvanised	100m
WA2234	1.5mm 7 x 7 Galvanised	250m
WA2235	1.5mm 7 x 7 Stainless Steel	100m
WA2239	2mm 7 x 7 Galvanised	250m
WA2240	2mm 7 x 7 Galvanised	100m
WA2241	2mm 19ply Galvanised	250m
WA2242	2mm 7 x 7 Stainless Steel	250m
WA2243	2mm 7 x 7 Stainless Steel	100m
WA2244	3mm 7 x 7 Galvanised	100m
WA2245	3mm 7 x 7 Stainless Steel	100m

hog ring pliers leaving the net taut and square with no gaps for birds to get through. A strong yet flexible 7x7 wire rope is available in either galvanised or stainless steel. 3mm, 2mm or 1.5mm diameter on 100m or 250m reels. A less flexible 19ply cable is also offered. Other specifications can be supplied.



## Barrel Strainers

Hook and eye strainers in galvanised or stainless steel. Size M5 and especially M6 are commonly used but we can supply the larger M8. For small areas, in stainless steel, we offer M4.

Cat No.	Description	Pack
WA2272	M5 Galvanised	10
WA2273	M6 Galvanised	10
WA2274	M8 Galvanised	10
WA2275	M6 Stainless Steel	Each
WA2276	M5 Stainless Steel	Each
WA2277	M4 Stainless Steel	Each
WA2278	M8 Stainless Steel	Each

See page 13 for example of use.

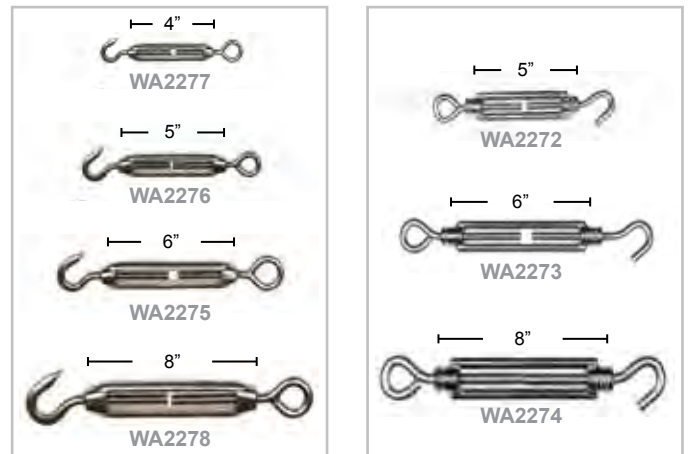

## Bostitch Hog Ring Pliers and Rings

Clip holds 50 hog rings. Spring loaded easy one-handed operation for attaching bird nets to wire. Hog rings are supplied in packs of 2,500. Choice of standard galvanised, triple life galvanised, aluminium or stainless steel.

Cat No.	Description	Pack
WA2246	Hog Rings Stainless Steel	2,500
WA2250	Bostitch P7 Pliers	Each
WA2251	Standard Hog Rings	2,500
WA2252	Aluminium Hog Rings	2,500
WA2249	Galfan Hog Rings (Triple Life)	2,500

## Hog Ring Plier Regur® DOZ 20

Ideal for efficient fastening of bird control netting and wire mesh. Uses Hog-Rings OK 20, Galvanised, Aluminium, V2A-Stainless.

- Sturdy
- Easy to use
- Loads full strip of 50 hog rings

Cat No.	Description	Pack
HP2250	Hog Ring Plier Regur® DOZ 20	Each



## Net Fixing

### Wire Rope Grips

3mm wire rope grips are available in galvanised or stainless steel and will fit 2mm, 2.5mm and 3mm wire rope.

Use 7mm nut spinner for Galvanised and Stainless steel fittings.

Cat No.	Description	Pack
WA2255	3mm Galvanised	50
WA2256	3mm Stainless Steel	10



### Nut Spinners

Eclipse nut spinners for rapid fitting of wire rope grips.

Cat No.	Description	Pack
WA2264	7mm Nut Spinner	Each
WA2265	7mm Flexible Nut Spinner	Each



### Wire Cutters

Felco C7 Wire Cutters - The best available, will cut wire rope up to 4mm diameter.

D8 Wire Cutters - A less expensive alternative to the C7, will cut wire rope up to 5mm diameter.

Cat No.	Description	Pack
WA2254	D8 Wire Cutters	Each
WA2257	Felco C7 Wire Cutters	Each



### Ratchet Crimp Pliers and Ferrules

Ratchet Crimp Pliers - For aluminium and copper ferrules.

Ferrules - For galvanised wire use aluminium ferrules and for stainless steel, copper ferrules should be used.

2mm Ferrules suit 1.5mm wire. 2.5mm Ferrules suit 2mm wire (On runs that exceed 5m or more 2 ferrules should be used at each loop). For 3mm wire use wire rope grips.

Cat No.	Description	Pack
WA2266	Professional Ratchet Crimp Pliers	Each
WA2258	Ratchet Crimp Pliers	Each
WA2259	2mm Aluminium Ferrules	100
WA2260	2mm Copper Ferrules	100
WA2261	2.5mm Aluminium Ferrules	100
WA2262	2.5mm Copper Ferrules	100

For Galvanised wire use Aluminum Ferrules  
For Stainless steel wire use Copper Ferrules

Wire	
1.5 mm	2 mm Ferrules
2 mm	2.5 mm Ferrules
3 mm	Wire rope grips

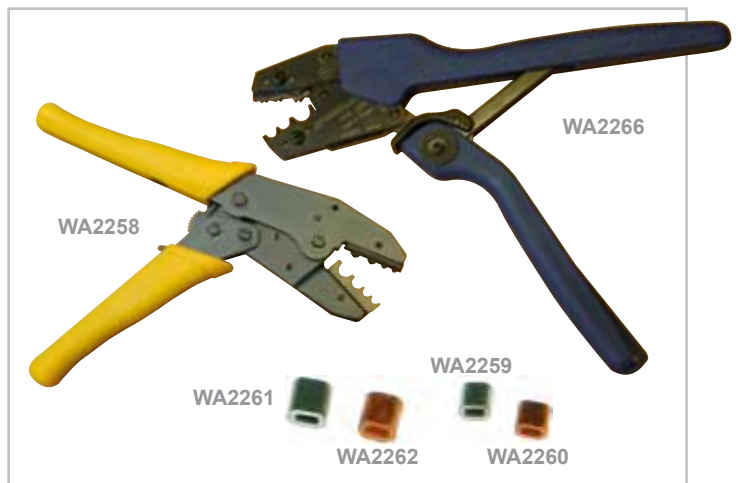

**Whatever fixings you choose to use you must never mix galvanised and stainless as it will result in a chemical breakdown of the stainless steel.**



### Cable Ties

Black nylon UV resistant cable ties used for attaching Birdchain to pipes or handrails up to 100mm (4") diameter.

Cat No.	Description	Pack
BC2042	Cable Tie 120mm x 4.8mm	100
BC2043	Cable Tie 200mm x 4.8mm	100
BC2044	Cable Tie 300mm x 4.8mm	100
BC2045	Cable Tie 430mm x 4.8mm	100

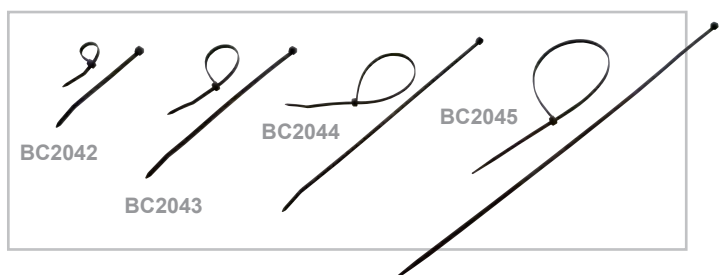



# Net Fixing

## Main Fixings

These main fixings are used to take the weight of the net.

### Eye Bolts and Hook Bolts

Standard M6 & M8 Eyebolts and Hook Bolts. High loadbearing main fixings complete with zinc passivated expander shields, for a heavy duty fixing. For M6 drill 11mm. For M8 drill 14mm. These carry the weight of the straining wire and netting and are used at the corners of the net and wherever the straining wire changes direction. They also support crosswires and on long runs should be used every 8 - 10m.

Cat No.	Description	Pack
WA2281	M6 Electro Zinc Eyebolt (Forged)	10
WA2282	M6 Galvanised Hook Bolt	10
WA2289	M8 Zinc Eyebolt (Forged)	10

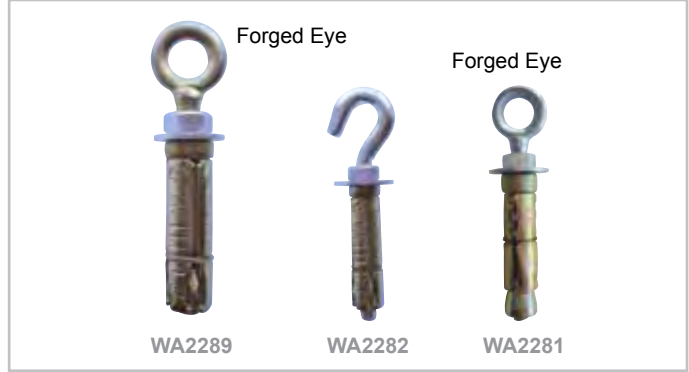

### Beam Bolts

Passivated eyebolts complete with fixings. A heavyweight fixing for attachment to flanges of girders. Drill size 6.5mm.

Cat No.	Description	Pack
WA2291	Beam Bolt Stainless Steel (Forged)	10
WA2292	Beam Bolt Galvanised (Forged)	10

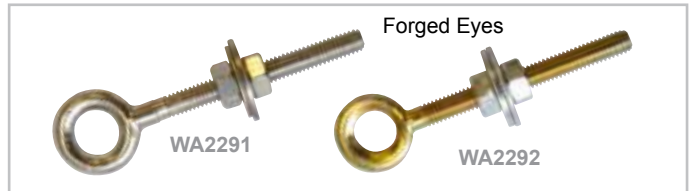

### M6 Stainless Steel Eyebolt

High specification welded M6 stainless steel eyebolt complete with penny washer and expander shield. Drill 11mm. Welded mini stainless steel eyebolt. Drill 8mm. Welded eye for extra strength

Cat No.	Description	Pack
WA2296	M6 Stainless Steel Eyebolt (Forged)	10
WA2300	Mini Stainless Steel Eyebolt (Forged)	10



### Bridge Clamps

Fixing for securing nets to metal girders. Jaw Size 20mm, jaw depth 20mm

Cat No.	Description	Pack
WA2290	Bridge Clamp	10

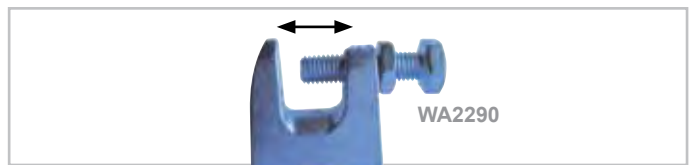

### Adjustable Bridge Clamps

Adjustable fixing for securing nets to metal girders. Jaw Size 19 - 50mm, jaw depth 25mm

Cat No.	Description	Pack
WA2297	Adjustable Bridge Clamp	Each



### Cladding Bolts (Forged Eye)

These bolts have expanding rubber shields which will fit irregular shaped holes and clamp behind thin materials. Available with 16mm or 26mm shield. Length 75mm, thread 45mm. Forged eye not welded for extra strength.

Cat No.	Description	Pack
WA2360	Cladding Bolt - Small Stainless Steel	10
WA2361	Cladding Bolt - Large Stainless Steel	10
WA2363	Cladding Bolt - Small Plated	10
WA2362	Cladding Bolt - Large Plated	10

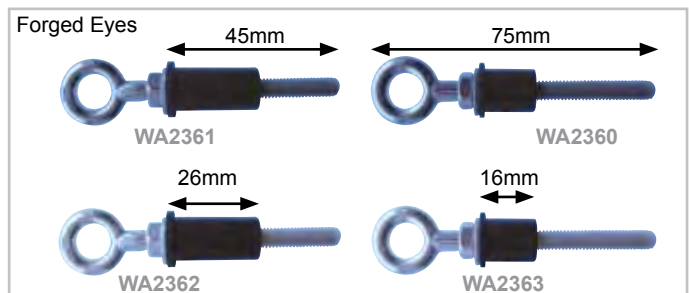

# Net Fixing

## Intermediate Fixings

These carry far less weight and tension than the main fixings and are used to hold the straining wire close against the structure.

### Multi-purpose Cable Bracket

An ideal stainless steel bracket which can be used as an end bracket, intermediate bracket, as a permanent fixture or as a quick release cable holder if access is needed behind netting.

Cat No.	Description	Pack
WA2294	Stainless Steel Bracket	100
WA2295	Stainless Steel Bracket (150mm)	10



### Hilti Slimline Hangers

Intermediate fixing for straining wire. Drill 6mm maximum. Simple hammer home fix.

Cat No.	Description	Pack
WA2299	Slimline Hilti Hanger	100



### Net Spike

A simple galvanised intermediate fixing. Simply drill a 5mm hole and hammer home.

Cat No.	Description	Pack
WA2306	Net Spike (Galv) Drill 5mm	100



### Screw Pin and Plug

Stainless steel intermediate fixing.

Cat No.	Description	Pack
WA2309	Stainless Steel Screw Pin	100
WA2319	Nylon Plug for Screw Pin	100

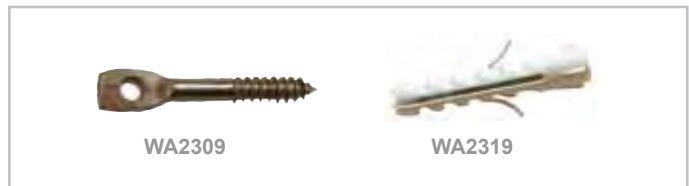

### Screw Eyes and Vine Eyes

The screw eye offers a very economical quality fixing and is available as a 100mm stainless steel vine eye, 75mm bright zinc plated vine eye, 40mm & 45mm stainless steel screw eye and a 40mm bright zinc plated screw eye.

Cat No.	Description	Pack
WA2311	40mm BZP Screw Eye	100
WA2312	40mm Stainless Steel Screw Eye	100
WA2320	45mm Stainless Steel Screw Eye	100
WA2314	75mm BZP Vine Eye	100
WA2315	100mm Stainless Steel Vine Eye	100

A collection of screw fixings for timber or stone if used in conjunction with a plastic plug.



Intermediate fixings are used to hold the wire tight against the structure. Their centres will depend on bird species and shape of net.

Bird	Typical Centres
Pigeon	1.0m
Gull	1.0m - 1.5m
Starling	0.5m
Sparrow	0.3m

# Net Fixing

## Plastic Plugs and Screws

Available in three sizes. See below for usage.

Cat No.	Description	Pack
WA2316	Yellow Plastic Plug	100
WA2317	Red Plastic Plug	100
WA2318	Brown Plastic Plug	100
WA2321	8 x 19mm Posi Panhead Stainless Steel	100
WA2322	8 x 25mm Posi Panhead Stainless Steel	100



Plug	Usage	Drill Size
Yellow	30 & 35mm screw eyes & hooks	5.5
Red	40mm screw eyes	6
Brown	45mm screw eyes & vine eyes	7

## Drive Rivets and Split Pins

Stainless steel split pins with grey nylon drive rivets are available in 2 sizes. Drill 6.5mm

Cat No.	Description	Pack
PW2191	25mm Split Pins Stainless Steel	100
PW2192	38mm Split Pins Stainless Steel	100
PW2193	25mm Nylon Drive Rivet	100
PW2194	38mm Nylon Drive Rivet	100



These are used as fixings for straining wire (page 14) or in conjunction with post & wire systems.

## Beam Clips

A selection of hammer-on secure intermediate fixings for straining wire or mesh panels where drilling is not an option.

Cat No.	Description	Pack
WA2331	2-4mm Galvanised	100
WA2332	5-9mm Galvanised	100
WA2333	10-16mm Galvanised	100
WA2334	17-20mm Galvanised	100



Galvanised beam clips fix to flanges of girders and beams up to 20mm thick.

## Super Clips

Special stainless steel beam clamps for fixing wire rope/netting close and along metal beams.

Cat No.	Description	Pack
SC0205	Super Clips 2-5mm S/S	100
SC0509	Super Clips 5-9mm S/S	100
SC0915	Super Clips 9-15mm S/S	100
SC1521	Super Clips 15-21mm S/S	100

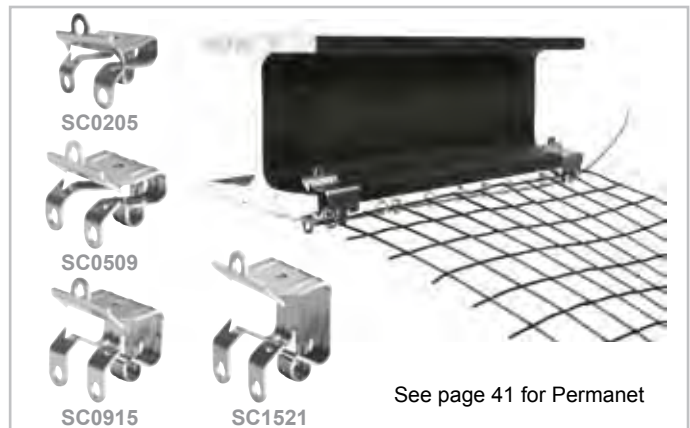

## Girder Clamps

Stainless steel bolt on clamp for flanges in excess of 20mm.  
50mm clamp fits 20 - 50mm flange.  
75mm clamp fits 40 - 75mm flange.

Cat No.	Description	Pack
WA2339	50mm Girder Clamp	10
WA2340	75mm Girder Clamp	10
WA8002	20mm Toothed Clamp	Each

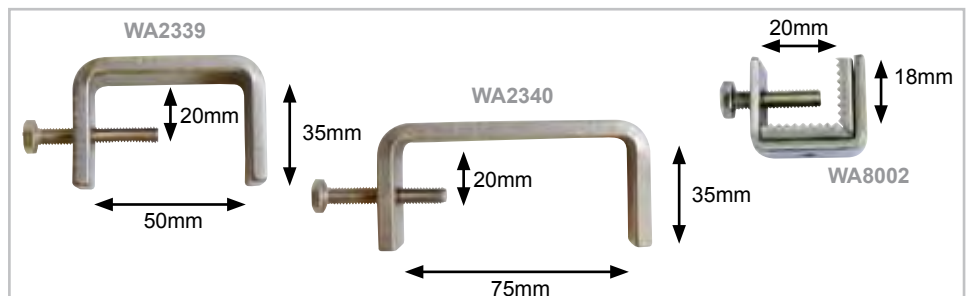



# Net Fixing

## Specialist Fixings

### Slate Bracket

Stainless steel, slide between slates to hold straining wire close to roof surface.

### Angle Bracket

25mm x 25mm zinc or 20mm x 20mm stainless steel.

Cat No.	Description	Pack
WA2341	25mm Angle Bracket Galvanised	100
WA2343	Stainless Steel Angle Bracket	100
WA2342	Stainless Steel Slate Bracket	10



### Net Hooks

Stainless steel net hooks used instead of zips for access.

### Nylon Hook

'S' shaped snap-on nylon hook to join two pieces of net or to provide occasional access for maintenance.

Cat No.	Description	Pack
WA2358	Net Hook 19mm Stainless Steel 316	100
WA2359	Net Hook 28mm Stainless Steel 316	100
WA2353	Net Hook 50mm Stainless Steel 316	100
WA2352	'S' Shaped Nylon Hook	100

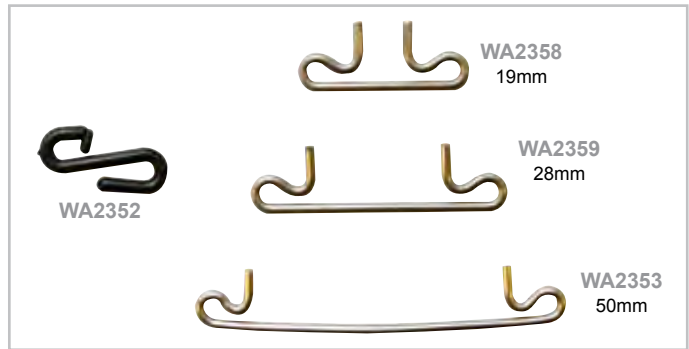

### Self Drill Screws

Available in two sizes and with BZP or Stainless Steel finish. With hexagonal head for special drill attachment.

### Bonded Washers

For use with self drilling screws. Available in stainless steel or galvanised.

### Hex Head Drill Attachment

Drill attachment for use with hexagonal head self drill screws.

Cat No.	Description	Pack
WA2347	25mm Stainless Steel Self Drill Screw	100
WA2344	25mm BZP Self Drill Screw	100
WA2349	20mm Stainless Steel Self Drill Screw	100
WA2345	19mm BZP Self Drill Screw	100
WA2346	Bonded Washers Stainless Steel	100
WA2351	Bonded Washers Galvanised	100
WA2350	Hex Head Drill Attachment 5/16th	Each



### Net Guides

Stainless steel intermediate fixing, low visibility for use with self drill screws.

Cat No.	Description	Pack
WA2357	Net Guides Stainless Steel	100



# Drill Bits

SDS Plus Masonry Drill Bits



Straight Shank Masonry Drill Bits



High Speed Twist Drills



## Drill Bits

SDS plus; Masonry & HSS. A range suitable for hand or power tools in stone, concrete, brick, steel, and other metals and timber.

### SDS Plus Masonry Drill Bits

Cat No.	Description	Pack
WA2379	SDS+ 5.5mm x 100mm	Each
WA2371	SDS+ 6mm x 100mm	Each
WA2372	SDS+ 6.5mm x 100mm	Each
WA2373	SDS+ 7mm x 100mm	Each
WA2374	SDS+ 8mm x 100mm	Each
WA2375	SDS+ 10mm x 100mm	Each
WA2376	SDS+ 11mm x 100mm	Each
WA2377	SDS+ 12mm x 100mm	Each
WA2378	SDS+ 14mm x 100mm	Each



### Straight Shank Masonry Drill Bits

Cat No.	Description	Pack
WA2381	SS 5mm x 85mm	Each
WA2382	SS 6mm x 150mm	Each
WA2383	SS 6.5mm x 150mm	Each
WA2384	SS 8mm x 150mm	Each
WA2385	SS 10mm x 150mm	Each
WA2386	SS 11mm x 150mm	Each
WA2387	SS 12mm x 150mm	Each
WA2388	SS 14mm x 150mm	Each

### High Speed Twist Drills

Cat No.	Description	Pack
WA2391	HSS 3.3mm	Each
WA2392	HSS 3.5mm	Each
WA2393	HSS 4mm	Each
WA2394	HSS 4mm Tungsten	Each
WA2395	HSS 5mm	Each
WA2396	HSS 6.5mm	Each
WA2397	HSS 6.5mm Tungsten	Each

		DRILL DIAMETER	DRILL DEPTH
WA2296	Stainless Forged M6 Eyebolt	11 mm	50 mm
WA2281	Standard Forged Eyebolt M6 BZP	11 mm	50 mm
WA2287	Eyebolt M8 BZP	14 mm	55 mm
WA2291	Beam bolt Stainless Forged	6.5 mm	n/a
WA2292	Beam Bolt BZP	6.5 mm	n/a
WA2298	Hilti Hanger	8 mm	50 mm
WA2306	Net Spike galvanised	5 mm	30 mm
PW2193	25 mm Drive Rivet	6.5 mm	28 mm
WA2299	Slimline Hanger	6mm	45mm
PW2194	38mm Drive Rivet	6.5mm	40mm
WA2325	50 mm Drive Rivet	6.5 mm	52 mm
WA2309	Stainless Steel Screw Pin [nylon plug]	6 mm	30 mm
WA2311	40 mm BZP screw eye [red plug]	6 mm	35 mm
WA2320	45 mm Stainless Steel [brown plug]	7 mm	40 mm
WA2312	40mm Stainless Steel Screw Eye [yellow plug]	5mm	22mm
PW2167	Gull Post [plug]	7mm	30mm

## Roof Mount

### Non-Piercing Roof Mount

Developed with the UK's leading Bird Control experts, this non corrosive aluminium non piercing roof mount offers complete piece of mind when tackling some of the most demanding bird control projects.

Constructed out of the most versatile materials for weather resistant performance and with TIG welded base, this new roof mount offers unrivalled performance and great value.

Supplied as standard with adjustable slab holdings.

Options:

- Roof Mount with 1m upright
- Roof Mount extension (1m)
- Neoprene base add on

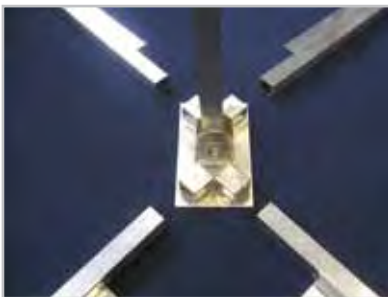

Cat No.	Description	Pack
RM0001	Roof Mount with 1m upright	Each
RM0002	Roof Mount extension (1m)	Each
RM0003	Roof Mount PVC base	Each



Images supplied by Avid Pest Control

## Standing Seam Clamp

### Standing Seam Clamp

Enables netting to be fixed securely to standing seam roof profiles. Made of aluminium

Standing Seam Clamp	Each
---------------------	------





# Spike Systems

Spike systems are a very effective and permanent protection against birds landing and roosting. They are a very good deterrent against pigeons and gulls but are not recommended for sparrows or starlings. We offer a wide selection of spike designs and styles for use on ledges, signs, ridges, beams, pipes, parapets, etc. All Huck Brandenburg spike systems have square cut wires to avoid injury to birds.



## ValuePoint Spikes

A spike system with a flexible base made from high quality UV-stabilised polycarbonate with stainless steel spikes. Ideal for use on ledges and due to flexibility of the base can be used on curved edges. Two lengths provide one metre of coverage.



**Excellent protection of narrow ledges up to 100mm (4") wide. A two-point spike system**

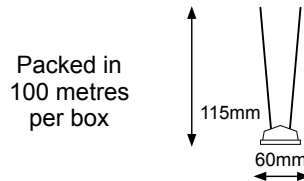
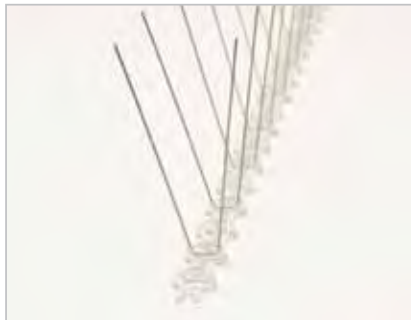

**Excellent protection to ledges up to 215mm (8.5") wide. A four-point spike system**

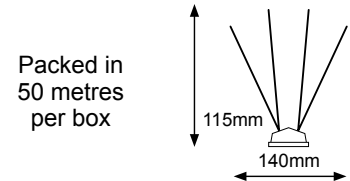
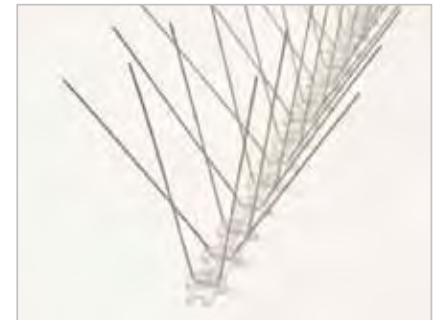

Cat No.	Description	Pack
VP02	ValuePoint System 2	160m
VP04	ValuePoint System 4	80m
VP05	ValuePoint System 5	50m
VPGC01	ValuePoint Gutter Clip	50



**Excellent protection of wide ledges up to 290 wide (10.5")**

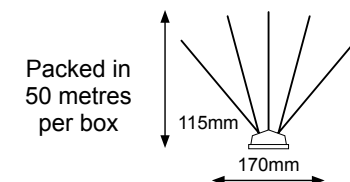

Installation by MITIE Pest Control

# Spike Systems

ValuePoint, Pro-Stack & PinPoint are spike systems that are easy to install and between them versatile and effective in most situations.

All Huck Brandenburg wires are square cut to avoid injury to birds

## INSTALLATION

Where spike systems are to be installed, the surface must be properly prepared. Ensure all surfaces are clean and dry; remove all dirt, bird droppings, loose and flaking paint, old adhesive, grease and oil. A low modulus neutral cure silicone such as Soudal [page 30] is recommended for polycarbonate bases [see page 30 also for other alternatives]. Each tube of adhesive should be sufficient to fix a run of 8-12m of spike system. Gaps between adjacent rows of spikes or between spikes and back walls should not exceed 65mm [2.5"] for pigeons and 100mm [4"] for gulls. Angled wires are more difficult to penetrate and the closer together they are the better the protection. Tips of angled wires should slightly overhang the front edge of the surface to prevent the birds landing.

# PROSTACK

**NEW Top Quality Spike Range!!**

### ProStack Pigeon Spike

- Wide glue base for maximum stability
- Stackable for ease of application
- Spike 1.4mm thickness

Product Dimensions -  
 L333xW155x133mm  
 Base Dimension - L333 x W40mm  
 Protects Area - up to 220mm  
 Spike Spread (distance from spike tip to opposite spike tip) - 155mm  
 Quantity of spikes per section - 24  
 Where to use - most building ledges

### ProStack Gull Spike

- Wide glue base of maximum stability
- Stackable for ease of application
- Spike 1.4mm thickness

Product Dimension -  
 L333 x W200 x H169mm  
 Base Dimension - L333xW40mm  
 Protects Area up to - 290mm  
 Spike Spread (distance from spike tip to opposite spike tip) - 200mm  
 Quantity of spikes per section - 24  
 Where to use - Most building ledges

Gull spikes have longer wires as gulls have longer legs and can straddle shorter spikes. Gulls are also aggressive and quite strong. They have been known to rip spikes out with their beaks. Therefore the spike installation needs to use stronger adhesive and cover the whole ledge to prevent the birds from landing adjacent to areas being protected



## PROSTACK P014

Protects ledges up to 200mm (7.9") wide from Pigeons

## PROSTACK PG14

Protects ledges up to 290mm (11.4") wide from Gulls

Cat No.	Description	Pack
P014	Stackable Pigeon 4 spike	metre
PG14	Stackable Gull 4 spike	metre

# Spike Systems

## PinPoint

PinPoint is an aggressive and robust product. It is British made, high quality, and extremely effective, but is low cost. It has a polycarbonate UV stabilised base and high grade stainless steel wires.



BRITISH  
MADE 

The following spikes are for use against Pigeons

**PINPOINT** **PP02** Plastic System

Protects ledges up to 100mm (4") wide from Pigeons

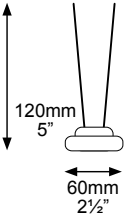
**PINPOINT** **PP04** Plastic System

Protects ledges up to 215mm (8 1/2") wide from Pigeons

**PINPOINT** **P002**

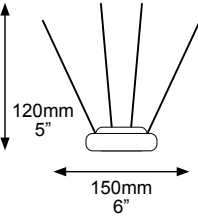
Protects ledges up to 100mm (4") wide from Pigeons

**PINPOINT** **P004**

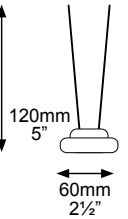
Protects ledges up to 215mm (8 1/2") wide from Pigeons

**PINPOINT** **P006**

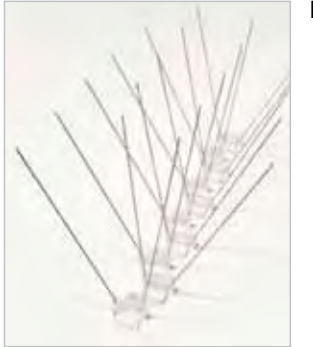
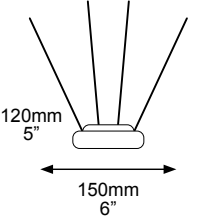
Protects ledges up to 275mm (11") wide from Pigeons

**PINPOINT** **PG04**

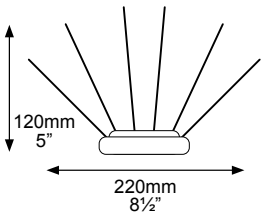
Protects ledges up to 275mm (11") wide from Gulls

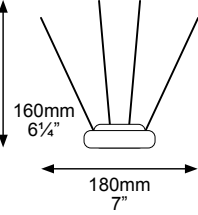

# Spike Systems

**System Protection... What spike system do you need for your size of ledge?**

Cat No.	Description	Protection	Pack
P002	PinPoint System P002	Protects ledges up to 4" [100mm]	Metre
P004	PinPoint System P004	Protects ledges up to 8½" [215mm]	Metre
PP04	PinPoint System PP04	Protects ledges up to 8½" [215mm]	Metre
P006	PinPoint System P006	Protects ledges up to 11" [275mm]	Metre
PG04	PinPoint System PG04	Protects ledges up to 11" [275mm]	Metre



## Rocking Spider

Designed to keep seagulls and pigeons off the top of street lights, air conditioning units and other larger surfaces. Just the lightest breeze or touch from the bird will set the 20 wires rocking back and forth, deterring the birds.

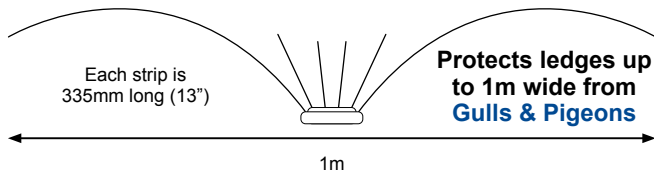

Cat No.	Description	Pack
PR001	PinPoint Rocking Spider	Metre

### PinPoint Gutter Clip

Allows the attaching of our P002, P004 and PP04 spike system to most guttering.

### PinPoint OG Gutter Clip

Allows the attaching of our P002, P004 and PP04 spike system to most OG style guttering.

### PinPoint Window Clip

Used to attach P002, P004 and PP04 directly to a window frame that opens outwards.

Cat No.	Description	Pack
PGC01	PinPoint Gutter Clip	10
PGC02	PinPoint OG Gutter Clip	10
PWC01	PinPoint Window Clip	10

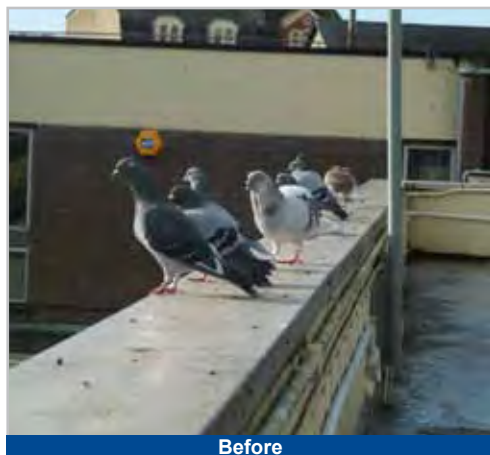

# Chimney Spikes

## Chimney Spike

The Scarborough chimney spike comprises a number of 3mm diameter stainless steel rods welded together. Supplied flat, each set can be bent into a suitable spike cluster on site for use against nesting gulls, particularly on and around the chimney stacks of domestic property. Screw or cement into position.

## PinPoint Chimney Pot Spike

Designed for seagulls, but also effective against pigeons. At 3½ft long and very flexible, it will wrap around chimney pots of every shape and size. No glue or tools required. It uses a powerful spring locking clip and serrated strap to hold itself in place.

Cat No.	Description	Pack
PW2198	Chimney Spike	Each
PC01	Pinpoint Chimney Pot Spike	Each



## Chimney Wire Balloon

Locate in chimney pot to prevent roosting birds.

Cat No.	Description	Pack
WA2452	Chimney Wire Balloon 2.5" (60mm)	Each
WA2453	Chimney Wire Balloon 3" (75mm)	Each
WA2454	Chimney Wire Balloon 4" (100mm)	Each
WA2456	Chimney Wire Balloon 6" (150mm)	Each
WA2458	Chimney Wire Balloon 8" (200mm)	Each
WA2459	Chimney Wire Balloon 9" (225mm)	Each

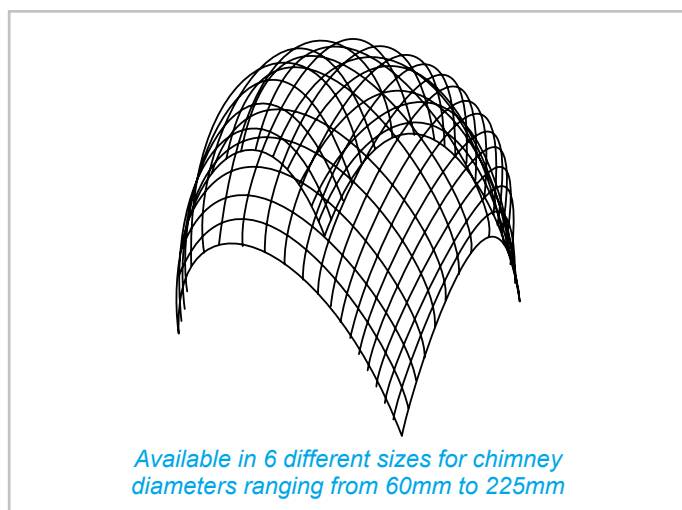

If you need any information or advice on Spike systems call **Dave Collins** or **Matt Thomas** on 01308 425100 or email [dave.collins@hucknetting.co.uk](mailto:dave.collins@hucknetting.co.uk) or [matt.thomas@hucknetting.co.uk](mailto:matt.thomas@hucknetting.co.uk)

## Post and Wire Systems

Post and wire systems have been used for many years to keep pigeons and gulls off building ledges, parapets, signs, beams, pipes, gutters, roof ridges, etc. The systems are cost effective, extremely versatile and a totally humane bird deterrent. If installed correctly are also very discreet.

By placing thin stainless steel wires tensioned with springs just above where the birds normally rest it will deter all but the most persistent birds from landing.

Post and Wire systems are the ideal solution for light pressure areas. They can also be used in medium pressure situations but if it is an area where there are numerous birds present in daytime extreme care must be taken when installing.

### All Stainless Post and Wire System

The protection of surfaces ranging from 10cm to 40cm deep can be accommodated. The leading post is 90mm and the intermediate posts in line are at 50mm centres. Secure using 25mm stainless steel posi panhead screws and plastic plugs. [page 19]  
Ideal for use on prestigious buildings against pigeons.

This is a complete pre-assembled stainless steel post system including stainless steel modular base. The one-piece base reduces the number of fixings normally required to be drilled into the structure for multiple strands of wire. Posts are 130mm and 90mm high.

Order units according to number of rows of posts required (minimum two row up to a maximum of eight rows). The photograph shows eight rows for ledges up to 40cm wide. See pages 33 and 34 for wire and springs etc.



Cat No.	Description	Pack
PW2152	Stainless Steel Base and 2 Posts	Each
PW2153	Stainless Steel Base and 3 Posts	Each
PW2154	Stainless Steel Base and 4 Posts	Each
PW2155	Stainless Steel Base and 5 Posts	Each
PW2156	Stainless Steel Base and 6 Posts	Each
PW2158	Stainless Steel Base and 8 Posts	Each

### Huck Standard Post and Wire System

All posts are manufactured using 4mm diameter 316 grade polished stainless steel. The posts have a 2.5mm coined hole to allow the free passage of the wire, and the ends are bevelled to aid insertion into the drive rivet or stick-on base.

Cat No.	Description	Pack
PW2160	180mm x 4mm Post	100
PW2161	150mm x 4mm Post	100
PW2162	130mm x 4mm Post	100
PW2163	130mm Stick-on Post and Base	10
PW2164	115mm x 4mm Post	100
PW2165	90mm x 4mm Post	100
PW2166	90mm Stick-on Post and Base	10
PW2171	Stick-on Base	100
PW2159	Stick-on Base White	100
PW2170	Stick-on Base Black	100



### Beam and Gutter Clamps

**Beam Clamp** - a bird wire post fixed to a stainless steel clamp. This allows a bird wire system to be attached to a flange of a steel beam.

**Gutter Clamp** - a bird wire post fixed to a stainless steel clamp. This allows a bird wire system to be attached to the leading edge of a gutter.

Cat No.	Description	Pack
PW2202	Beam Clamp	10
PW2203	Gutter Clamp	10

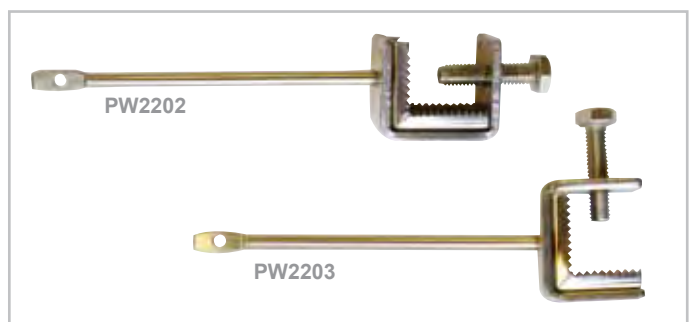



# Post and Wire Systems

## Multi Headed Posts and Gutterposts

Manufactured using 4mm diameter polished stainless steel, same as the standard post [page 32] but with multiple holes for horizontal or vertical installations.

The gutterpost will fit 3mm - 7mm thickness.

Cat No.	Description	Pack
PW2172	180mm Double (75)	100
PW2173	180mm Triple (50)	100
PW2174	150mm Double (75)	100
PW2176	130mm Double (50)	100
PW2179	90mm Gutterpost	10

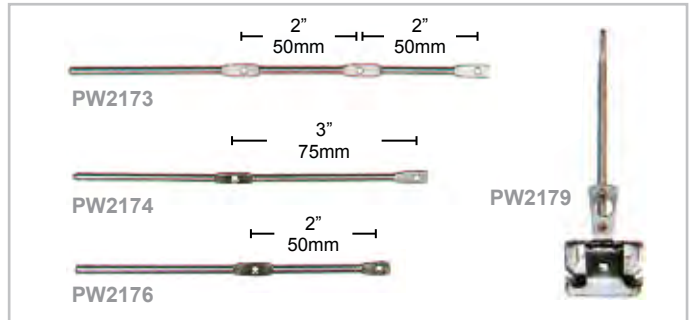

## Soudal Fix ALL High Tack (grey)

Provides high adhesion onto building substrates such as stone, brickwork, treated wood, glass and plastics etc. Other types are available.

## Soudal Surface Activator

Surface Activator is a cleaner, degreaser and primer all-in-one. It will activate non-porous surfaces such as plastics, coatings and metals for improved adhesive.

Cat No.	Description	Pack
SA4004	Soudal Fix ALL High Tack (grey)	Each
BC2041	Soudal Surface Activator	500ml



## Rail Clamps

Rail clamps for attaching post & wire system to rails or pipes. Comprising 90mm posts welded on to expandable 100mm diameter stainless steel bands. Other sizes can be made to order.

Cat No.	Description	Pack
PW2177	Rail Clamp 100mm x 1 Post	Each
PW2178	Rail Clamp 100mm x 2 Post	Each



## Gull Post and Wire System

A heavy duty version of the pigeon post and wire system. Gull posts are 5mm diameter x 200mm long stainless steel. Plugs are 6mm.

0.96mm S/S wire is secured to posts using 1mm copper ferrules.

Cat No.	Description	Pack
PW2167	Gull Post 5mm x 200mm	100
PW2168	6mm Plug for Post	100
PW2185	Gull Wire 0.96mm Stainless Steel	250m
PW2187	Copper Ferrule 1mm	100
PW2188	Standard Spring	100
PW2190	Micro Spring	100



## Nylon Coated Bird Proofing Wire

For use on post and wire systems. 0.45mm 1 x 7 stainless steel wire, UV stabilised clear nylon coated to 0.7mm finished diameter. Choice of reel sizes.

Cat No.	Description	Pack
PW2181	Nylon Coated Wire	500m
PW2182	Nylon Coated Wire	250m
PW2183	Nylon Coated Wire	100m
PW2184	Nylon Coated Wire	50m



## Post and Wire Systems

### Crimps

Nickel plated copper crimps for attaching nylon coated wire to posts and split pins. (Close using crimping tool below)

Cat No.	Description	Pack
PW2186	Crimps	100



### Birdwire Crimping Tool

A two in one tool, used to crimp and cut birdwire.

Cat No.	Description	Pack
PW2175	Birdwire Crimping Tool	Each



### Springs

A stainless steel spring manufactured for use with post and wire systems. A smaller less conspicuous stainless steel mini-spring is also available.

Cat No.	Description	Pack
PW2188	Standard Spring	100
PW2189	Mini Spring	100



### Split Pins

Stainless steel split pins (4mm) for use with drive rivets to attach bird proofing wire to window reveals and recesses.

Cat No.	Description	Pack
PW2191	25mm Split Pins	100
PW2192	38mm Split Pins	100



Installed by Beaver Pest Control, London

# Post and Wire Systems

## Drive Rivets

High impact thermoplastic drive rivets for securing stainless steel posts and split pins in stone, brick etc. Drill 6.5mm. Available in lengths 25mm for posts or 25mm and 38mm for split pins.

Cat No.	Description	Pack
PW2193	25mm Drive Rivets	100
PW2194	38mm Drive Rivets	100



## Drilled Support Rods

Stainless steel 6mm diameter rods with countersink holes at 75mm centres to support multiples of bird proofing wire horizontally above areas that cannot be drilled (lead, bitumen, decorative stone-work etc). Three lengths are available from stock.

Cat No.	Description	Pack	No. of Holes
PW2195	300mm Support Rod	10	4
PW2196	450mm Support Rod	10	6
PW2197	600mm Support Rod	10	8

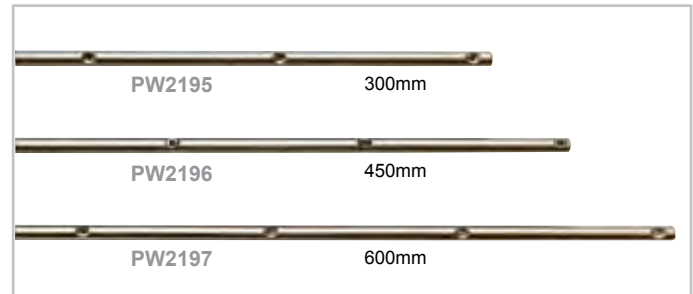

## Ridge Brackets

A selection of brackets for fitting bird proofing to both triangular and half round ridges.

Cat No.	Description	Pack
RF2230	Ridge Bracket 3 Post Triangular	Each
RF2231	Ridge Bracket 5 Post Triangular	Each
RF2232	Ridge Bracket 2 Post Half Round	Each
RF2234	Gull Ridge Bracket 3 Post Triangular	Each
RF2236	Gull Ridge Bracket 3 Half Round	Each



## Roof Net Supports

## Roof Net Supports

Cat No.	Description	Pack
RF2225	Roof Net Support 30cm Triangular	Each
RF2226	Roof Net Support 30cm Half Round	Each
RF2227	Roof Net Support 45cm Triangular	Each
RF2228	Roof Net Support 45cm Half Round	Each



## Roof Spike

Designed to hold net wires above roof ridges. These spikes can be hammered through the mortar between the ridge tiles into the wooden ridge board below. They can be weather-proofed using the sealants or adhesive [see page 30]

Cat No.	Description	Pack
RF2237	Roof Spike 45cm Stainless Steel	Each
RF2238	Roof Spike 53cm Stainless Steel	Each
RF2239	Master Flash Sealers (Mini)	Each



## Capital Bracket

A fixing to hold a net straining wire away from the building to prevent the net becoming frayed on any sharp feature such as column capitals. Made in stainless steel.

Cat No.	Description	Pack
WA2356	Capital Bracket Stainless Steel	Each

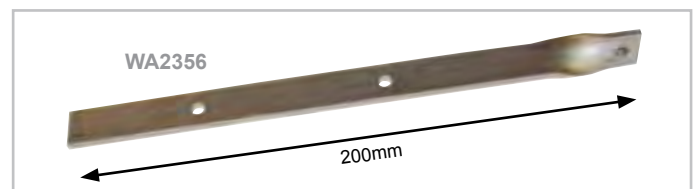



## Post and Wire Systems

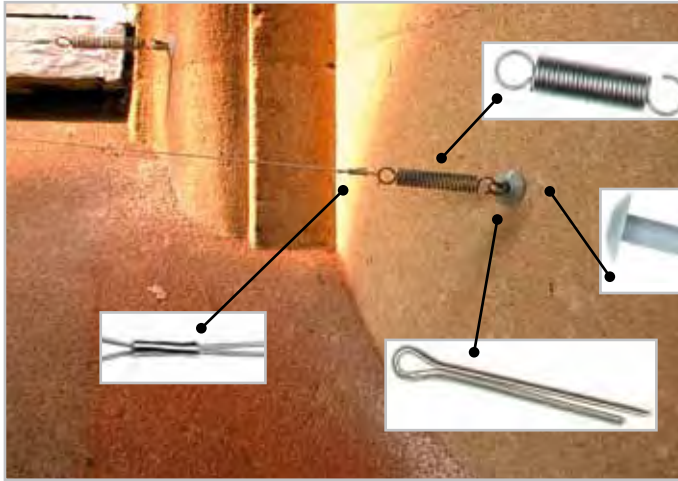

### Installation

Care should be taken when installing post and wire systems as damage can be caused when drilling. Holes for drive rivets should be 6.5 mm diameter x 28 mm deep and at no more than 75 mm centres across the ledge, with typically 1.5 m to the next holes along the length to be proofed. 150 mm and 115 mm posts should be used.

Where drilling is not possible [on metal flashings] stick-on posts can be used. These posts are shorter than standard as none of the length is 'lost' below the surface [use 130 mm and 90

mm posts] with stick-on bases. A rapid set adhesive should be used [page 30]. Do not stick onto dirty or greasy surfaces, new lead flashing [the surface has an oil coating], painted or glazed surfaces, copper or slate [the glue will only stick to the top layer], deteriorated stone or brickwork, soft stone [the tension on the post may cause damage]. Also do not stick on heavily oxidised girders or old lead, asphalt or mineral felt, wet or icy surfaces.

Multi headed posts are available for a variety of applications both horizontally and vertically. [page 32]

Bird	Height of front wire	Height of wire in rear rows	Distance between posts	Distance between rows of wire
Pigeon	90-95 mm	125-135 mm	Max 1.5 *	Light pressure – max 75 mm Medium pressure – max 65 mm
Black Headed Gull	160–180 mm	n/a	2m	Max 90 mm
Herring Gull	160–200 mm	n/a	3m	Max 125 mm

### Wire Reel Holder

Speeds up installation as prevents wire from tangling and reels rolling away.

- Designed specifically to hold wire reels for bird work
- The reels drop onto the centre of the spindle
- Wire can be pulled off as required

Cat No.	Description	Pack
WR0001	Wire Reel Holder	Each



If you need any information or advice on Post and Wire systems call **Dave Collins** or **Matt Thomas** on 01308 425100 or email [dave.collins@hucknetting.co.uk](mailto:dave.collins@hucknetting.co.uk) or [matt.thomas@hucknetting.co.uk](mailto:matt.thomas@hucknetting.co.uk)

# Post and Wire Systems

## Bird Track

For applications where the deterrent is to be as invisible as possible use the BirdTrack Wire System.



For small pipes secure with self adhesive tape and plastic ties. For larger pipes secure with silicone adhesive and plastic ties [see page 30]

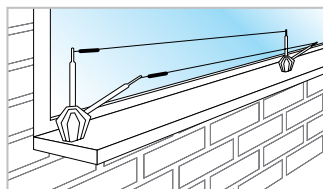
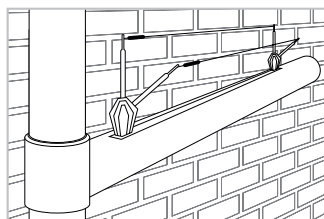

Use on horizontal ledges and vertical faces. Can also be used upside down for application on overhang above ledge.

With a choice of 1, 2 or 3 wires a variety of widths and areas can be covered.

The base is secured by adhesive with additional securing pins at the end. For pigeons the gap between the wires should be 50 mm supported by 90 mm long posts. For gulls the gap between the wires should be 75 mm with 150 mm long posts.

Parts to be ordered separately for self assembly. Wires can be supplied cut to required length. Please specify.



BirdTrack is available in dark grey, light grey or stone colour

Cat No.	Description	Pack
PS2505	Bird Track 5 x 1M strips	5M Packs

## ScareGull

The seagull deterrent that really does work!!



- Scaregull is a unique, British made, easy to fit seagull deterrent.
- Scaregull is manufactured from glass reinforced nylon which is ultra violet and salt water resistant, lightweight and hard wearing.
- Scaregull is 5ft in diameter and turns on a 6" stainless steel pin driven by a pair of rotating sails.
- Scaregull includes our standard mounting block.

- Seagull deterrent • Eco friendly
- Eliminates gull mess
- Stops gulls landing • Wind powered
- Easy to fit • Harmless to gulls
- Less time cleaning



*Scaregull can be mounted on sailing and motor boats or on the roofs of seaside or riverside buildings where seagulls are a nuisance - particularly restaurants and cafés*

Cat No.	Description	Pack
SG1001	ScareGull	Each

## Daddi Long Legs

### Daddi Long Legs

For use against pigeons & gulls on flat roofs, air conditioning units, streets lights etc.

Can be screwed or glued in place, (use base adaptor when gluing). Wires should extend just beyond the area to be protected. Tips should be no more than 100mm above surface.



Cat No.	Description	Pack
PW2200	Daddi Long Legs 1.2m diameter	Each
PW2201	Daddi Long Legs 2.4m diameter	Each
PW2204	Daddi Long Legs Glue Base	Each



# Audible Systems

## Patrol 2

Hand held portable bird dispersal system complete with in-built siren, live announcement facility and showerproof carrybag – no accessories, adapter or add-ons necessary. Standard distress calls included - Herring, Common and Black Headed Gulls, Lapwing, Starling, Rook, Magpie, Pigeon and Crow.

Cat No.	Description	Pack
1307	Scarecrow Patrol 2	Each

## Goose Patrol

Hand held portable Canada Goose bird dispersal system complete with in-built siren, live announcement facility and showerproof carrybag. Standard distress calls included - Canada Geese 1, 2, 3 & 4; Pigeon, Herring Gull, Blackheaded Gull, Starling and Rook.

Cat No.	Description	Pack
1309	Scarecrow Goose Patrol	Each

## One-Shot

Fully automatic and random play, bird dispersal processor and power amplifier, wall mounting, 12Vdc operational. Standard distress calls included - Pigeon, Starling, Herring & Black Headed Gulls, Rook & Jackdaw; site programmable. See 1208 under LOUDSPEAKERS for long line extension facilities.

Cat No.	Description	Pack
1308	One-Shot	Each

The choice and quantity of loudspeakers to be supplied with ONE-SHOT is dependant on the type, size and site application details. When this information is provided to Huck Nets a system will be designed to suit the specific needs of the application.

Silver Gull, Ring Billed Gull, Yellow Legged Gull, Black Starling, Jackdaw, Jay, Blackbird, Red Winged Blackbird, Sparrow, Song Thrush, Carrion Crow, Crested Myna, White Ibis, Canada Goose and Oystercatcher



If you need any information or advice on Audible systems call **Dave Collins** or **Matt Thomas** on 01308 425100 or email [dave.collins@hucknetting.co.uk](mailto:dave.collins@hucknetting.co.uk) or [matt.thomas@hucknetting.co.uk](mailto:matt.thomas@hucknetting.co.uk)

## Bird Free® Gel

Not a spike or wire insight!

### Bird Free® Gel

- New ready-to-use dishes
- Cuts your installation time in half
- Quick, easy, mess-free installation
- Making working at heights safer and easier
- Firm texture enables use on pitched roofs and angled surfaces
- More discreet low profile dishes
- Keeps all pest birds away from structures without harming them

### Bird Free Gel Magnetic Dishes

Cat No.	Description	Pack
BF0001	15 x 8mm low profile dishes per pack	Box of 15

### Adhesives

Cat No.	Description	Pack
SA1001	Soudal Siliirub 2 Neutral Silicone (clear)	each
SA4004	Soudal FixALL High Tack (grey)	each
BC2039	Skeleton Caulking Gun	each

Soudal Siliirub 2 - Application temperature: +5°C to +25°C  
 Soudal FixALL - Application temperature: +5C until +25C

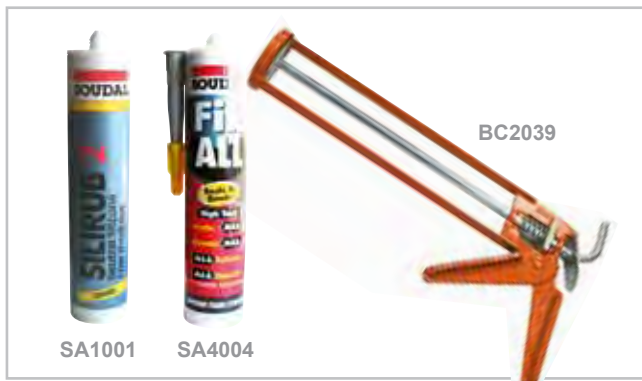

### Bird Free has solved the following problems:

- Where pigeons had been nesting in nooks and crannies of an historic building for centuries. No matter how many times the nest were removed they would always rebuild them. The nests were removed and bird free was successfully applied
- Where the façade of a building had been heavily infested with pigeons for several years necessitating frequent cleaning of the windows and pavement below. All faeces were removed from the infested areas and Bird Free was successfully applied.

AS A GUIDE, ONE TUBE OF ADHESIVE  
 WILL GLUE 90 DISHES

# BIRD FREE® GEL

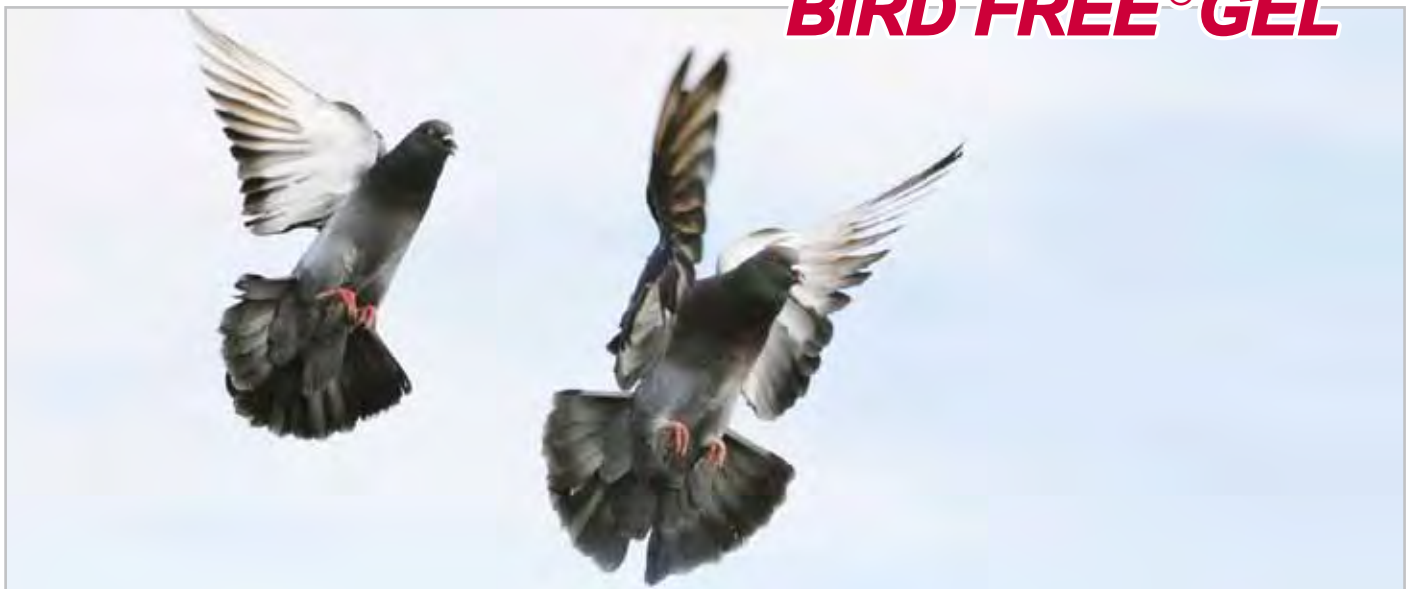

## Weldmesh

Weldmesh, like netting, is an effective barrier against birds that are nesting at night. It is the solution for areas where it is difficult to attach a tensioned wire system as it can be cut to shape and size. It also can be bent to fit.



**Pigeon**

Size of Mesh: 50mm x 50mm



**Starling**

Size of Mesh: 25mm x 25mm



**Sparrow**

Size of Mesh: 25mm x 12.5mm

### Weldmesh

Weldmesh is a welded wire mesh which is manufactured from metal wires welded at their intersections. By using different diameter wires it can be made into a light or heavy gauge



**WM0001**

Mesh size 25mm x 12.5mm  
1" x 1/2"



**WM0002**

Mesh size 25mm x 25mm  
1" x 1"



**WM0003/WM0004**

Mesh size 50mm x 50mm  
2" x 2"



**WM0005/WM0006**

Mesh size 6.5mm x 6.5mm  
1/4" x 1/4"

Cat No.	Description	Size
<b>WM0001</b>	Weldmesh 12.5mm x 25mm (16 gauge)	0.915m x 6m roll
<b>WM0002</b>	Weldmesh 25mm x 25mm (16 gauge)	0.915m x 6m roll
<b>WM0003</b>	Weldmesh 50mm x 50mm (12 gauge)	0.915m x 25m roll
<b>WM0004</b>	Weldmesh 50mm x 50mm (12 gauge)	1.22m x 2.44m panels
<b>WM0005</b>	Weldmesh 6.5mm x 6.5mm (21 gauge)	0.915m x 25m roll
<b>WM0006</b>	Weldmesh 6.5mm x 6.5mm (21 gauge)	0.915m x 6m roll



# Weldmesh

## Permanet 304 Stainless Steel Nets

Welded stainless steel nets in rolls of 1.5m x 25m

**NEW**

Cat No.	Description	Pack
PN0730	Wire 0.7mm, 30x30mm	1.5m x 25m roll
PN1030	Wire 1.0mm, 30x30mm	1.5m x 25m roll
PN0719	Wire 0.7mm, 19x19mm	1.5m x 25m roll
PN1019	Wire 1.0mm, 19x19mm	1.5m x 25m roll

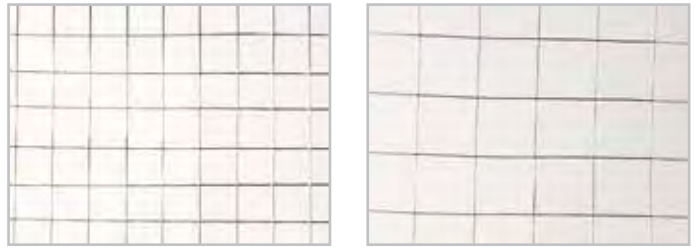

## Permanet 304 Stainless Steel Nets Black

Welded stainless steel nets in rolls of 1.5m x 25m with UV-0 stabilized black powder coating.

**NEW**

Cat No.	Description	Pack
PN0730B	Black Wire 1.0mm, 19x19mm	1.5m x 25m roll
PN0719B	Black Wire 1.0mm, 30x30mm	1.5m x 25m roll

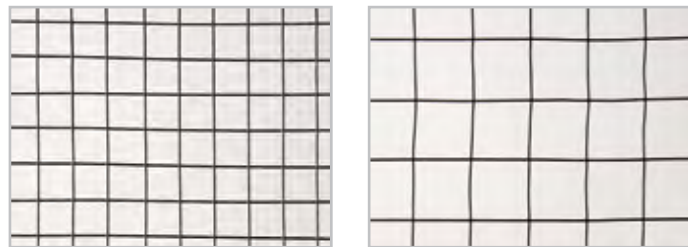
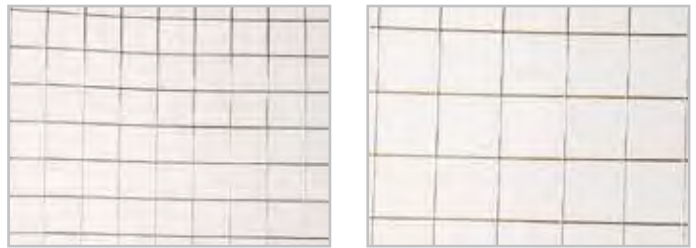

## Netholder Stainless Steel

Flexible, high quality fixing for wire rope and direct fixing of stainless steel netting, approx 37x25mm

**NEW**

Cat No.	Description	Pack
PNN50	Netholder Stainless Steel	50

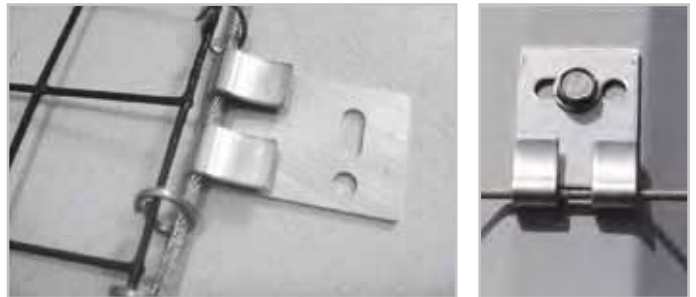

## Hog Ring Tool

A lightweight and handy tool for joining a wide range of applications. Quick and easy to apply, they form a tight connection between products.

Cat No.	Description	Pack
WM0019	Hog Ring Tool	Each
WM0017	Galvanised Hog Rings	100
WM2501	Galvanised Weldmesh Clip	100



If you need any information or advice on Weldmesh call **Dave Collins** or **Matt Thomas** on 01308 425100 or email [dave.collins@hucknetting.co.uk](mailto:dave.collins@hucknetting.co.uk) or [matt.thomas@hucknetting.co.uk](mailto:matt.thomas@hucknetting.co.uk)

# Brush Solutions

## Industrial Brush Strip

Brush Strip will help prevent draughts and dust entry. Brush Strip is supplied in 3m lengths (other lengths may be available on request).

Brush Strip, when pop riveted to the top or bottom of doors, will prevent small birds and rodents from entering a building.

Sections of Brush Strip are available in a choice of three styles of aluminium holder:-

Upright flange: 45° angle & 90° horizontal flange.

Brush lengths from 25mm to 150mm are available in 2-3 working days.

Please specify brush length and style of holder when ordering.



Cat No.	Description	Pack
BS2402	25mm S1 Upright / M	3m
BS2403	35mm S2 Upright / M	3m
BS2404	50mm S2 Upright / M	3m
BS2405	75mm S3 Upright / M	3m
BS2406	100mm S3 Upright / M	3m
BS2407	150mm S3 Upright / M	3m
BS2409	25mm S1 45° / M	3m
BS2410	35mm S2 45° / M	3m
BS2411	50mm S2 45° / M	3m
BS2412	75mm S3 45° / M	3m
BS2413	100mm S3 45° / M	3m
BS2414	150mm S3 45° / M	3m
BS2416	25mm S1 90° / M	3m
BS2417	35mm S2 90° / M	3m
BS2418	50mm S2 90° / M	3m
BS2419	75mm S3 90° / M	3m
BS2420	100mm S3 90° / M	3m
BS2421	150mm S3 90° / M	3m

*Carriage will be quoted on order*

## Concertina Door Kits

When ordering please state make of door, width of individual panel and number of panels. Complete kits can be supplied for popular types of concertina doors. Usually panels are 9" or 12" wide and are supplied with one nose piece per two panels. Length of brush is 25mm.

Cat No.	Description	Pack
BS2422	9" Panel Door Kit	Panel
BS2423	12" Panel Door Kit	Panel

## Shutter Seal

Shutter Seal has been designed to fit all types of roller shutter door, both on guides and bottom rails. The seal not only reduces heat loss from draughty doors it also muffles the rattles from which roller doors suffer and acts as deterrent against pests and rodents.

Shutter Seal is available in 3m lengths and in a choice of 3 different brush lengths (25, 35 & 50mm).

Cat No.	Description	Pack
BS2425	25mm Shutter Seal	Each
BS2426	35mm Shutter Seal	Each
BS2427	50mm Shutter Seal	Each



## Bird Bristle

Provides a simple barrier to birds in eaves, cable ducting and other electrical enclosures

Flexible Birdbristle is constructed with a corrosion resistant twisted core with tough synthetic bristles.

Cat No.	Description	Pack
BB0001	Bird Bristle - Length 2.6, Diameter 75	Each
BB0002	Bird Bristle - Length 2.6, Diameter 100	Each
BB0003	Bird Bristle - Length 5.2, Diameter 75	Each
BB0004	Bird Bristle - Length 5.2, Diameter 100	Each



## Rodentbrush

Provides a simple barrier to rodents in eaves, cable ducting and other electrical enclosures.

Constructed in fire retardant and insulated materials. Laid around cables and enclosures or filling the cavities it acts as a deterrent to rodents whilst allowing air to circulate and water to drain away.

Rodentbrush is Network approved

Cat No.	Description	Pack
RB0001	Rodent Bristle - Length 5.2, Diameter 100	Each



## Prickler

Keep cats and burglars away

### Prickler

The Prickler consists of an array of closely arranged cones formed from weather-proof PVC. The individual pieces measure 460mm (1.5ft) x 48mm (1.8 inches).

Designed to deter prowlers and predators, without harm, the Prickler is supplied individually or in packs of eight (total length approximately 3.6m (12ft)).

Cat No.	Description	Pack
PS2500	The Prickler Urban Deterrent - Brown	Each
PS2501	The Prickler Urban Deterrent - White	Each

Easy to cut with a junior saw, can be glued or screwed... versatile... reusable... durable

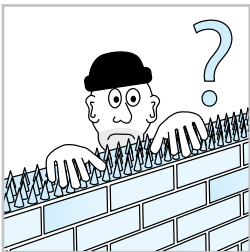

WALLS

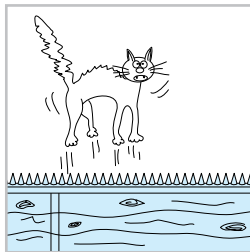

FENCES

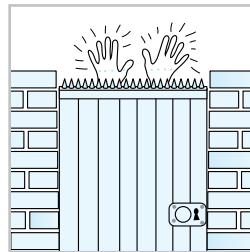

GATES

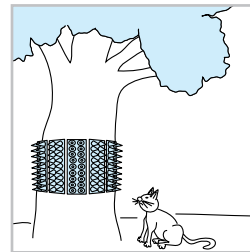

TREES

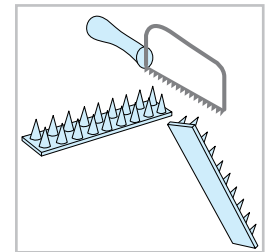

EASY TO CUT

## Custom Metal Work

Available to order, custom metal work in both galvanised and stainless steel, send us your drawings for a quotation



If you need any information or advice on Custom Metal Work call **Dave Collins** or **Matt Thomas** on 01308 425100 or email [dave.collins@hucknetting.co.uk](mailto:dave.collins@hucknetting.co.uk) or [matt.thomas@hucknetting.co.uk](mailto:matt.thomas@hucknetting.co.uk)



## Aviary Netting

We manufacture and supply aviary netting manufactured in our high quality knotless netting.



### Benefits of using our high tenacity UV resistant polypropylene knotless netting for aviaries:

**Hard wearing** - The mesh is very strong and guarantees superior shock absorption.

**Easy to install** - The shape of the nets makes it much easier to install them.

**Aesthetically pleasing** - Improved weaving technology improves the appearance of the nets.

**Precise mesh size** - The woven mesh has an interlocking design and cannot move.

**Very little abrasion/extremely chafe-resistant** - Doing away with knots produces high chafe-resistance and ensures that only slight abrasion occurs where the netting mesh interconnects.





# Aviary Netting

But don't just take our word for it...

*"We have been using netting from Huck Nets for our bird enclosures for many years. We have one huge aviary that we installed some 6 or 7 years ago and the netting is still in good condition. The netting is suitable for most birds, it is soft so doesn't damage the birds and it is also strong and durable,"* Said Hawk Conservancy Curator, Andy Hinton

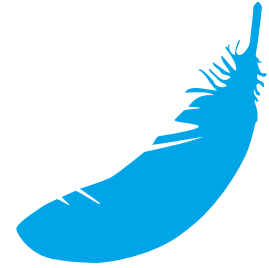

As we manufacture our own netting it can be custom made to any size. All colours and mesh sizes are available although the most common for aviaries is black netting with a mesh size of either 20mm or 40mm.

Cat No.	Description	Pack
200-040-06	2.3mm twine x 40mm mesh	m <sup>2</sup>
200-020-06	2.3mm twine x 20mm mesh	m <sup>2</sup>
209-045-06	3mm twine x 45mm mesh	m <sup>2</sup>



If you need any information or advice on Aviary Netting call **Dave Collins** or **Matt Thomas** on 01308 425100 or email [dave.collins@hucknetting.co.uk](mailto:dave.collins@hucknetting.co.uk) or [matt.thomas@hucknetting.co.uk](mailto:matt.thomas@hucknetting.co.uk)

# Personal Protective Equipment and Tools

## Coveralls

Pro.Tech - Model Classic

1. 3 piece hood
2. Elasticated facial opening
3. External stitched seams (3 thread overlock)
4. Elasticated waist
5. Elasticated cuffs and ankles
6. Zipper flap
7. Additional Gusset fabric

Cat No.	Description	Pack
HS2513	Coveralls	Pair



## PX-Ornikill

Protects workers and the public from the risk of ornithosis and other bird related diseases.

- Effective against a wide range of disease causing organisms
- Apply as a dust suppressant during work or as a surface biocide
- Flexible dilution rates for spraying or wiping

Cat No.	Description	Pack
HS2510	PX-Ornikill	1 Litre



## Guanaway

A ready to use professional spray for use in control of micro-organisms, associated with the cleaning up of bird waste and collection of pest bodies.

Guanaway passes BS6471 against E-Coli and contains a powerful degreaser to neutralise the acid associated with bird droppings.

Cat No.	Description	Pack
HS2511	Guanaway	750ml



## Humane Despatcher

Cat No.	Description	Pack
HD0001	Humane Despatcher	Each



## Metal Scraper

Cat No.	Description	Pack
HS2514	Metal Scraper 75mm	Each





## Personal Protective Equipment and Tools

### Wire Brush

Cat No.	Description	Pack
HS2515	Wire Brush 4 Row Brass	Each



### Metal Shovel

Cat No.	Description	Pack
HS2516	Metal Shovel	Each



### Soft Brush

Cat No.	Description	Pack
HS2517	Soft Brush 11"	Each



### Nitrile Rubber Gloves

Cat No.	Description	Pack
HS2518	Nitrile Rubber Gloves	Pair



### Rigger Gloves

Cat No.	Description	Pack
HS2520	Rigger Gloves	Pair



### Dust Masks

Cat No.	Description	Pack
HS2521	Dust Masks	50



### Uc-p3v Mask

Cat No.	Description	Pack
HS2524	Uc-p3v Mask	10



### Profile 2 Half Mask

Cat No.	Description	Pack
HS2526	Profile 2 Half Mask	Each



### Promask Full Face P3 Mask

Cat No.	Description	Pack
HS2525	Promask Full Face P3 Mask	Each
HS2527	P3 Filters	



# Personal Protective Equipment and Tools

## Disposable Gloves

Cat No.	Description	Pack
HS2522	Disposable Gloves	100



## Safety Goggles

Cat No.	Description	Pack
HS2523	Safety Goggles	Each



## Silicone Eater

Silicone sealant remover. Removes all types of sealant from most surfaces. For adhesive products see page 30.

Cat No.	Description	Pack
BC2046	Silicone Eater	Each



## Wonder Wipes

Cat No.	Description	Pack
WW0001	Wonder Wipes	100



## Waste Sack

Cat No.	Description	Pack
HS2519	Waste Sacks	10



## Expanding Foam

Soudafoam 1K B2 with CFC-free propellant is a one-component, self expanding, ready to use polyurethane foam with propellants which are completely harmless to the ozone layer and has a fire rating to B2 (DIN 410Part 2).

Cat No.	Description	Pack
EF0001	Expanding Foam	750ml



## 594 Rapid Silicone Tube Cutter

Safely & neatly trims cap and spout of silicone tubes.

Cat No.	Description	Pack
SA5005	594 Rapid Silicone Tube Cutter	Each



## Just a few examples of other types of netting in stock at Huck Nets UK Ltd.

Art. No.	Description	Colour	Material Width (mm)	Mesh Size (mm)	Weight g/sq.m.	Max Tensile strength of mesh (kN)	Usage
200-020	PP high tenacity, knotless	●●○●	2.3	20	180	0.80	Golf / Debris
200-040	PP high tenacity, knotless	●●○●●	2.3	40	90	0.80	Anti Litter
200-100	PP high tenacity, knotless	●○●	2.3	100	50	0.80	Sport
200-120	PP high tenacity, knotless	●●○	2.3	120	35	0.80	Sport
201-025	PP high tenacity, knotless	●	1.8	25	100	0.60	Golf / Debris
1202-020	PP high tenacity, knotless	○●●	1.0	20	50	0.20	Bird
1202-030	PP high tenacity, knotless	○●●	1.0	30	30	0.20	Bird
1202-050	PP high tenacity, knotless	○●●	1.0	50	20	0.20	Bird
1203-010	PP high tenacity, knotless	● (diamond mesh)	1.5	10	150	0.25	Industrial
203-075	PP high tenacity, knotless	●	1.5	75	12	0.25	Bird
203-100	PP high tenacity, knotless	●	1.5	100	15	0.25	Bird
207-045	PP high tenacity, knotless	●	3.5	45	200	1.40	Play
209-045	PP high tenacity, knotless	●○●●●●●	3.0	45	150	1.25	Play / Lorry
209-075	PP high tenacity, knotless	●	3.0	75	75	1.25	Anti Litter
209-100	PP high tenacity, knotless	●○●●	3.0	100	75	1.25	Sport
209-120	PP high tenacity, knotless	●○●●	3.0	120	65	1.25	Sport
218-045	PP high tenacity, knotless	●○●●●●●	5.0	45	400	3.20	Cargo / Safety
218-060	PP high tenacity, knotless	●	5.0	60	300	3.20	Safety / Walk On
218-100	PP high tenacity, knotless	●○●●●●●	5.0	100	200	3.20	Safety
212-300	PP high tenacity, knotless	●	5.0	300	55	3.50	Line Crossing
215-045	PP high tenacity, knotless	●○●●●●	4.0	45	210	1.60	Lifting
215-100	PP high tenacity, knotless	●○●●●	4.0	100	110	1.60	Sport
215-120	PP high tenacity, knotless	●○●●●●	4.0	120	90	1.60	Sport / Safety

All dimensions are approximate values; we reserve the right to make slight modifications.

### Colour table

● = 01 = Green	● = 015 = Dark Green	○ = 02 = White	● = 03 = Orange	● = 04 = Blue
● = 05 = Yellow	● = 06 = Black	● = 07 = Red	● = 08 = Hemp coloured	● = 09 = Violet

### Some useful measurement conversions

Feet to metres multiply by 0.3048

Metres to feet multiply by 3.281

Sq metres to sq feet multiply by 10.76

Sq feet to sq metres multiply by 0.0929



# Flying Insect Control Systems

## Translucent Technology

Brandenburg products that employ TT™ (Translucent Technology) emit more than twice the UVA output of an equivalent, non TT™ unit, providing you with increased light intensity resulting in a faster rate of insect catch, reducing the risk from flying insects, faster, than ever before.

- Increased UVA Output • Fewer Units Required
- Increased Food Safety • Improved Customer Experience
- Reduction in Energy Consumption • Reduction of Carbon Footprint
- Lower Servicing Costs • Quick Return on Capital



## Double The UVA Power

TRANSLUCENT  
TECHNOLOGY

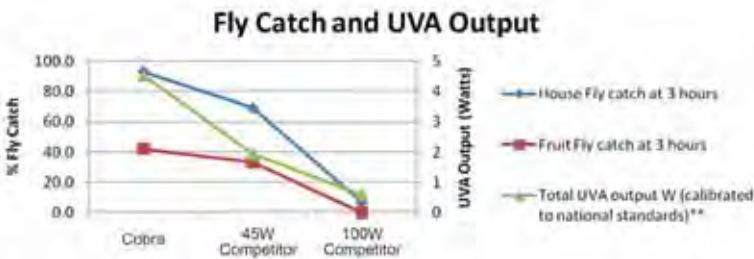
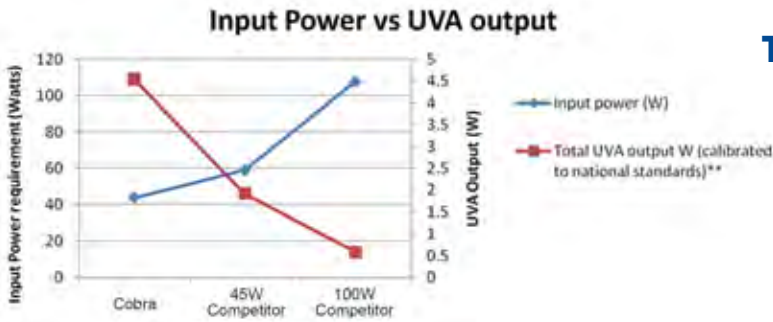

...more than just a fly trap



*COBRA catches 93.2% of all house flies within 3hrs*

*COBRA catches 41.6% of all fruit flies within 3hrs*

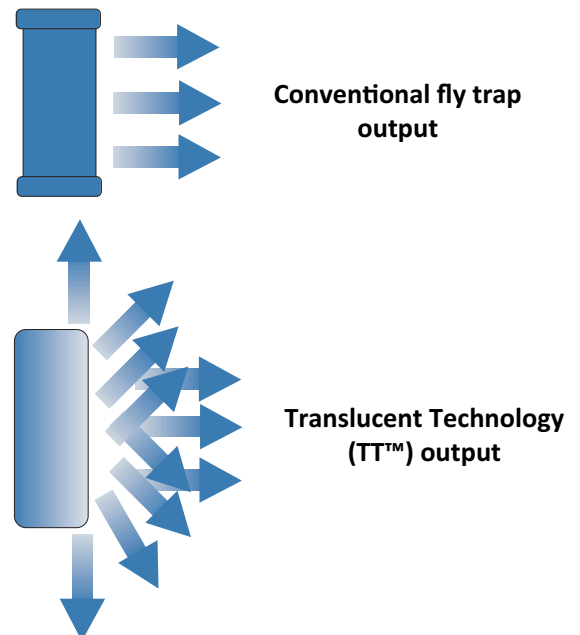

# Flying Insect Control Systems



**Genus® | COBRA™**

### Genus® Cobra™

Proven in laboratory tests, Translucent Technology™ makes GENUS® COBRA™ the most effective flying insect control unit of its kind, consistently outperforming competitor units by offering more than twice the UVa light output.

Its translucent cover and internal reflector panels give 'all-round' UVa transmission and fewer blind spots for a larger, 180° UVa footprint and maximum attraction area. It is even effective against smaller, hard to catch species like Fruit Flies.

In public areas, GENUS® COBRA™ provides silent, discreet, out of sight control with Translucent and Flystar Grey cover options to complement any decor.

For back of house locations, the options of the 45 Watt UVa output and the IP45 certified GENUS® COBRA™ Jet unit wet-wash areas makes it the ideal solution in any operating area. Easy access 'hands-free' servicing and wipe-down cleaning ensure continuous assured control and smart, hygienic appearance at, all times.

### Features & Benefits

- Translucent Technology™ allows 180° dispersal of UVa light increasing flying insect catch
- Quick release facia for easy & fast servicing
- Wipe clean slim line design for smart, hygienic appearance
- Available with a translucent or grey facia cover
- Optional IP45 rated unit for use in wet & wash-down areas
- HACCP compliant control board system with large catch area [201 sq in/1300 sq cm]
- Certified to World Wide standards for assured regulations compliance
- Full 5 year product warranty
- Low energy efficient ballast

Restaurants	Fast Food	Food Production
Bars	Supermarkets	Commercial Kitchens

Model	Description	Dimensions	Weight	Lamps
CT315	Cobra Translucent	344 x 528 x 128	4.75kg	3 x 15W
CG315JP	Cobra Jet Proof	344 x 528 x 128	4.75kg	3 x 15W
CG315	Cobra Grey	344 x 528 x 128	4.75kg	3 x 15W

# Flying Insect Control Systems



## Genus® | Optica 180



### Genus® Optica 180™

The GENUS® Optica 180™ brings together the latest developments in materials and unit design to give 180° 'all-round' UVa attraction and assured flying insect control.

It features silent operation and discreet catch control for public areas and the robust performance needed for hard-use production areas plus an IP65 option for wet-wash and damp working conditions. It is completely insecticide free and is even effective against smaller, hard to catch species such as Fruit Flies.

It is the perfect solution for every customer location from hotels and restaurants to retail and food processing where the presence of flying insect, pests presents a risk to health, product quality and reputation.

Hotels	Bars
Restaurants	Kitchens
Retail	Food Handling
Quick Service Restaurants	Warehouse

### Features & Benefits

- Translucent Technology™ and uniquely positioned lamps increase flying insect catch rate
- Side opening glueboard access
- Wipe clean slim line design for smart, hygienic appearance
- HACCP compliant control board system with large catch area [201 sq.in/1300 sq cm]
- Quick release & pull facia gives easy access for bulb replacement & tool free maintenance
- Certified to World Wide standards for assured regulations compliance
- 45 watt unit (3 x 15 watt tubes)
- Full 5 year product warranty
- Low energy efficient ballast

Model	Description	Dimensions	Weight	Lamps
OpticaT315	Optica 180™ Translucent	435 x 523 x 104	4kg	3 x 15W
OpticaJP315	Optica 180™ Jet Proof	435 x 523 x 104	4kg	3 x 15W



# Flying Insect Control Systems



## Genus® | LIBERATOR



### Genus® Liberator

The Genus® Liberator has been designed to offer the highest level of flying insect control for the toughest of environments.

The development of this range focused upon excellent design and quality with the primary emphasis placed upon achieving optimum performance and maximum reliability. All products are certified to meet Worldwide safety regulations and units are independently tested to ascertain efficiency levels.

The Genus® Liberator unit is one of the quickest and easiest to service insect light traps on the market. The units are very economical to run and are available in either white or stainless steel and can be both wall mounted or ceiling suspended.

Additionally the units are available with jet proof options (IP45) for use in the toughest environments. The insects are attracted to the unit by four 15W UVA lamps.

Food processing	Supermarkets	Commercial kitchens
Foods production	Shops	Quick Service Restaurants

### Features & Benefits

- Robust product, designed and engineered for the toughest environments
- High UVA output and insect attraction with 4 x 15W UVA lamps
- Tool free servicing and maintenance
- Each unit offers the convenience of two mounts – suspended from the ceiling or mounted on the wall
- Killgrid or glueboard options
- Certified to meet Worldwide safety regulations
- Full 5 year product warranty
- Low energy efficient ballast

Model	Description	Dimensions	Weight	Lamps
LWK/LWC	Liberator White Killer/Catcher	465 x 490 x 170	10kg	4 x 15W
LSK/LSC	Liberator Stainless Killer/Catcher	465 x 490 x 170	10kg	4 x 15W
LJK/LJC	Liberator Jet Killer/Catcher	465 x 490 x 170	10kg	4 x 15W

# Flying Insect Control Systems



**Genus<sup>®</sup> | VIPER™ II**

## Genus™ Viper™ II

The Genus™ Viper™ II has been specifically developed to offer insect control for commercial premises who require efficient products at a competitive price.

The range has been designed and built to the highest standards and all units carry international safety certifications. They are easy to service, can be either wall mounted, ceiling suspended or free standing and is available as a HV Killer or Catcher Unit.

All models are fitted with two 15 Watt UVA lamps, which ensure optimum attraction to flying insects. Once attracted to the unit the insect is hygienically and securely trapped on to a glue board, or in the case of the high voltage model, electrocuted and safely collected in the deep catch tray.

## Features & Benefits

- Stylish and professional design
- Worldwide Electrical Safety Certification
- Optional Sleeved Safety Lamps
- Easy Tool-Free Maintenance
- Free Standing, Wall Mounted or Suspended
- Deep Catchment Tray

Shops	Kitchens	Bakeries
Take-Aways	Hotels	Supermarkets

Model	Description	Dimensions	Weight	Lamps
ViperCIEC	Viper II Catcher IEC	320 x 520 x 120	3.5kg	2 x 15W
ViperKIEC	Viper II Killer IEC	320 x 520 x 120	4.5 kg	2 x 15W

# Flying Insect Control Systems



## Genus® | Spectra

### Genus® Spectra

The GENUS® Spectra products have been designed for high UVa output to achieve the quickest flying insect catch rate. Increasing customer awareness has led to a demand for higher level of hygiene and food safety. GENUS® Spectra and GENUS® Spectra Compact have been designed with these needs in mind.

The Spectra range uses the latest innovations in operation. The uniquely positioned bulbs maximise the UVa output and ensure flies head unobstructed, straight for the discreetly placed Brandenburg Universal Glue Board. The 1 or 2 x 36W bulbs are powered by electronic ballast. Finished with an attractively designed hinged screen panel, the GENUS® Spectra products not only boast a powerful performance, but ensure ease of servicing and complete discretion.

The innovative design features and powerful performance of the GENUS® Spectra and GENUS® Spectra Compact result in a fast reduction in flying insect populations and immediate improvement in customer environment. Suitable for use in both sensitive areas and for locations with heavy flying insect activity.



### Features & Benefits

- Maximum attraction - Uniquely positioned 1 or 2 x 36W bulbs for faster catch rates
- High catch rate - Specially angled control board result in higher catch rate
- Easy to service - Easy-to-access control board location, ensures optimum servicing
- 'Flicker Free' UVa output - Electronic Ballast gives constant, energy-efficient attraction
- Easy to maintain - Electronic Ballast eliminates replacement starters reducing energy and running costs
- Innovative design - Slim-profile, lightweight design and screen fascia for both front and back of house locations
- Compact design - Spectra Compact is small and lightweight for areas with limited space
- Discretion in public areas - Unique design, silent operation and out-of-sight catch area for total discretion
- Sanitary and compliant - Large control board surface for easy disposal of catch and full HACCP programme compliance
- Low energy efficient ballast

## Genus® | Spectra Compact

Model	Description	Dimensions	Weight	Lamps
SPE72-1S1201	Genus Spectra 72 Watt	318 x 525 x 69	3.4kg	2 x 36w
SPC36-1S1201	Genus Spectra 36 Watt	163 x 525 x 69	2kg	1 x 36w



# Flying Insect Control Systems



## Genus® | Eclipse™ (Front of House Units)

### Genus®Eclipse™

The GENUS®Eclipse™ is the result of the fusion of design-led development, the very latest advances in UVA transmission technology and customer-driven demand for a unit to bring effective control of flying insects to the most sensitive public areas.

GENUS®Eclipse™ has been designed to take on a completely different appearance to that of a traditional insect light trap, with a shape and style formulated to blend discretely into front-of-house locations. This discrete appearance, silent operation and the totally out-of-sight insect catch system, and the GENUS®Eclipse™ is the ultimate mix of discretion and performance in flying insect control.

The new 'TT™ light blade technology' provides forward angle reflection, concentrating the UVA output to minimise blind-spots and maximise the UVA footprint for efficient and effective flying insect attraction.

GENUS®Eclipse™ has innovative service features that improve safety and reduced service time. The unit features a side-hinged fascia allowing for servicing and maintenance to take place with both hands free.

In every way, GENUS®Eclipse™ is the realisation of modern, discreet and effective flying insect control.

### Features & Benefits

- Design led styling, silent operation and discreet, out-of-sight control for sensitive front-of-house locations
- New, low visible light 'black-light-blue' bulbs for maximum discretion in use
- New GENUS®Eclipse™ Light Blades' concentrate UVA 'visibility' to insects for increased attraction
- 2 x 15w, 12" side mounted bulbs, for maximum flying insect attraction
- Unit fascia colour options to complement any decor and room colour choices. Ask for details
- Out-of-sight large fully marked control board ensuring high catch capacity, complete discretion and HACCP compliance
- Side-hinged fascia – ensuring easy, fast and safe servicing to save time and maintain performance
- Electronic Ballast engineering for reduced running costs, increased power and fewer replacement parts
- Low energy efficient ballast

Restaurants	Hotels	Reception Areas
Bars	Display Areas	Offices
Leisure Facilities	Retail	

Model	Description	Dimensions	Weight	Lamps



# Flying Insect Control Systems

## Genus® Illumè

The Genus® Illumè flying insect control unit has been designed in a timeless art deco style that can be incorporated within any interior decor. It is designed to offer discreet insect control for all "front of house" areas such as bars and restaurants and it will also grace any home environment.

The Illumè uses well-proven ultraviolet light technology to draw the insects into the body of the unit. The light is created by a very efficient, 26W compact, fluorescent lamp uniquely developed by our designers for its compact size yet very high light output. Once attracted the insects are then trapped on specially formulated glue boards. The boards are cleverly hidden from view within the illumè body and can be quickly and easily changed as required.

The Genus® Illumè can be supplied in a range of colours to suit your decor. The unit can be hard wired or alternatively a mains lead and plug is supplied to facilitate easy installation.

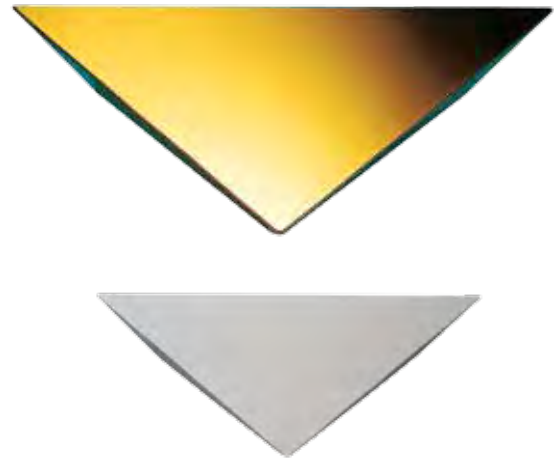

**Genus® | ILLUMÉ™**

(Front of House Units)

### Features & Benefits

- Designed to look like a modern lighting fixture makes Genus® Illumè perfect for sensitive front of house locations
- 26 Watt UVA lamp output lamp offers a greater flying insect attraction than alternative ILTs
- Available in a range of colours to compliment or contrast existing decor
- Large HACPP compliant glue board system offering largest [discreet] catch area
- Low energy efficient ballast

Restaurants	Bars	Shops
Receptions	Take-aways	Homes

Model	Description	Dimensions	Weight	Lamps
U12-001	White Wall Mount	445 x 142 x 140	2.2kg	1 x 26W Compact

## Genus® Sabre

The Genus® Sabre is a uniquely stylish insect control unit suitable for the home, office or restaurant.

Utilising the scientifically proven power of ultraviolet light to attract flying insects, the Genus® Sabre uses a specially formulated glue board to retain insects for disposal.

The unit is fitted with a 9W compact fluorescent bulb that is easily changed. The shade is designed in an elegant polished stainless steel which will complement any room decor.

There is simply not a more stylish product around, and best of all it is backed by the Brandenburg reputation for high performance flying insect control performance.

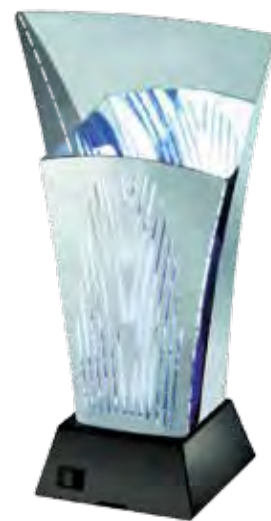

Take-Aways
Shops
Offices
Homes

### Features & Benefits

- Silent operation and out of sight catch area makes Genus® Sabre perfect for sensitive locations
- Suitable for the home or workplace
- Maintain effective performance through easy, fast and safe servicing
- Its stable base unit means the Genus® Sabre can be positioned on any flat surface

Model	Description	Dimensions	Weight	Lamps
Genus® Sabre	Mirror Polished	350 x 100 x 100	1.5kg	1 x 9W

**Genus® | Sabre**

# BB Alert - Bed Bug Monitoring System

The BB ALERT® product range has been specifically developed by MidMos Solutions as environmentally friendly and pesticide-free components of Bed Bug control programs. All the BB ALERT® products have been created using the applied expertise of leading entomologists, and extensively tested for efficiency within actual Bed Bug control programs. Providing a continuous, cost effective solution for monitoring the presence of Bed Bugs.



## Passive Monitor

The BB ALERT® Passive Bed Bug monitor is easy to install and quick to check. It designed for routine long term monitoring of susceptible areas, and provides an inexpensive way to discreetly detect the early signs of Bed Bug activity. The BB ALERT® Passive Bed Bug monitor contains no pesticides, requires no maintenance, and will provide continuous monitoring for up to 12 months. It is available for use by home owners, pest control professionals, and in-house commercial service and maintenance staff.



BBPM-1

Cat No.	Description	Pack
BBPM-1	BB Alert Passive Monitor	2

## Active Monitor

The BB ALERT® Active Bed Bug monitor is a revolutionary new attractant device for Bed Bugs. It is designed for use as a stand alone Bed Bug detector for susceptible areas, or to support and monitor the progress of Bed Bug elimination programs. The BB ALERT® Active Bed Bug monitor is discreet, easy to install and use, and contains no pesticides. It is available for use by home owners, pest control professionals, and in-house commercial service and maintenance staff.



BBAM-1

Cat No.	Description	Pack
BBAM-1	BB Alert Active Monitor	Each

## Activator

The BB ALERT® Active replaceable activator is supplied in a sealed package. When opened and exposed to the air it starts to generate heat and moisture, which together are mimics of the mammalian respiration signs that triggers a feeding response in Bed Bugs. The activator is placed inside the BB ALERT® Active base and enclosed by the insulated top cover.



BBA-1

Cat No.	Description	Pack
BBA-1	BB Alert Activator	Each



# Conditions of Sale

We offer goods and accept orders only upon and subject to the following terms and conditions which shall form part of any Contract concluded between us to the exclusion of any other terms and conditions except as specified on the face of our acceptance of an order or as otherwise agreed in writing.

Within these conditions 'us,' 'we' and 'The Company' shall refer to Huck Nets (UK) Limited.

## 1. General

1.1 All offers of our goods are subject to the following:

1.1.1 Our acceptance within 30 days after the date of your order.

1.1.2 Availability of the goods at the date of receipt of your written order.

1.1.3 Our right to correct errors and omissions in our catalogue or offer within 7 days of receiving your written order.

1.2 Your order must be for goods offered by us. Drawings, dimensions and weights submitted must be taken as approximate only and do not form part of the contract unless so stated in our catalogue or offer document.

1.3 All extras and accessories ordered but not specified in our catalogue or offer document will be charged separately, as will the costs of test, alterations and other work undertaken at the Buyers request.

1.4 Special conditions attached to orders are not binding unless accepted by the Company in writing. Any special conditions so accepted apply only to the transaction concerned unless otherwise expressly agreed in writing.

1.5 These conditions shall not be varied unless agreed in writing by one of the Company's directors.

1.6 The Company's employees or agents are not authorised to make any representations concerning goods unless confirmed in writing by one of the Company's directors.

## 2. Guarantee

2.1 We warrant that the goods will at the time of delivery correspond to the description given by us. Except where the Buyer is dealing as a consumer all other warranties, conditions or terms relating to fitness for purpose, quality or condition of the goods and whether implied by statute or common law or otherwise are excluded.

2.2 The guarantee contained in this condition does not affect the buyer's statutory rights.

## 3. Changes in specification

3.1 We reserve the right to change at any time and without notice the materials, dimensions of design of the goods so long as such change does not materially affect their performance and such changes shall not affect the validity of any Contract between us and the Buyer.

## 4. Prices

4.1 Unless otherwise stated, all prices quoted are for goods ex our works. Packing and carriage costs will be charged as extras to the Buyers account.

4.2 All prices quoted are subject to alteration without notice to take account of fluctuations or of alterations in Import Duty or Exchange Rates which may occur between the publication of our catalogue, the date of our offer and the date of our invoice and of any alteration in the rate of Value Added Tax.

4.3 We shall be entitled to adjust the price to take into account any delay on the part of the Buyer in supplying information required to complete his order or of any alterations made by the Buyer to specification or other information by the Buyer.

4.4 Where applicable Value Added Tax will be added to the prices determined in accordance with this condition and will be payable by the Buyer.

## 5. Payment

5.1 The Company shall be entitled to invoice the Buyer for the price of the goods on or at any time after delivery of the goods or if the Buyer is to collect the goods at any time after the Company has notified the Buyer that the goods are ready for collection.

5.2 The Buyer shall pay the price of goods without deduction within 30 days of the Company's invoice (time being of the essence) notwithstanding that delivery may not have taken place and property in the goods has not been passed to the Buyer.

5.3 If the Buyer fails to make payment in accordance with this clause the Company shall be entitled to cancel the contract by written notice to the Buyer or to suspend further deliveries to the Buyer or to charge the Buyer interest on monies unpaid at the rate of 3% per annum above Lloyds TSB Bank Plc base rate from time to time until payment in full is made.

## 6. Time for delivery

6.1 Dates quoted for delivery of goods are approximate only, and the Company shall not be liable for any delay in delivery however caused. Time for delivery shall not be of the essence unless previously agreed in writing in accordance with clause 1.5. Time for delivery is to be computed from the date on which both the following conditions are satisfied.

6.1.1. We have received a written Order or Contract from the Buyer and

6.1.2. We have in our possession all the information we require to complete the Buyers order.

6.2 We will use our best endeavours to comply with our quoted delivery dates but we will not be liable for any loss, damage, injury or expenses either direct or indirect and including but not limited to loss of profits or liability to third parties which may be suffered by the Buyer by reason of late delivery of the goods from whatsoever cause such late delivery may arise.

## 7. Delivery

7.1 Goods sold "ex works" will be despatched in accordance with the Buyers instructions and the risk of such goods will pass to the Buyer from time of loading at our Works.

7.2 Goods sold "delivered" will be despatched by whatever means of transport we choose unless a specific method of transport has previously been agreed in writing. The risk of the goods will pass to the Buyer when they reach the destination named by the Buyer and before unloading.

7.3 Ownership of goods sold by us shall not pass to the Buyer until the Company has received in cash or cleared funds payment in full of the price of goods until such property passes to the Buyer, the Buyer shall hold goods as the Company's fiduciary agent and bailee and shall keep goods separate from those of the Buyer and properly stored, protected, insured and identified as the Company's property. Until ownership passes the Buyer shall be entitled to resell or use goods but shall account to the Company for the proceeds of sale of goods (including insurance proceeds) and such proceeds shall be kept separate from other monies or property of the Buyer.

7.4 Until such property in goods passes to the Buyer the Company shall be entitled at any time to require the Buyer to deliver up goods to the Company and if the Buyer fails to do so forthwith on demand to enter upon the Buyer's premises or a third party's premises where the goods are stored and repossess the goods.

## 8. Copyright

The Company reserves the Copyright in all its drawings, sketches, plans, print and other documents or data. No reproduction thereof shall be made without permission of the Company and neither the drawings nor reproduction thereof shall be transferred to a third party without the permission of the Company.

## 9. Loss or damage in transit

We accept no liability for loss or damage in transit except in the case of goods sold "delivered" and in such case our responsibility will be limited to replacing or repairing the missing or damaged goods, or at our option, refunding the purchase price. In any event no claim will be considered unless both the carriers and ourselves are notified in writing within the following time limits:

9.1 Goods by Rail. In the case of damaged goods within 3 days after receipt and in the case of non-delivery within 21 days after date of despatch as notified by us.

9.2 Goods by Road Transport. In the case of damaged goods, immediately on receipt, and in the case of non-delivery, within 7 days after date of despatch as notified by us.

## 10. Trade marks

No trademark or name carried on goods supplied by us may be erased or replaced without our consent.

## 11. Insolvency of buyer

11.1 This clause applies if:

11.1.1 the Buyer makes any voluntary arrangement with its creditors or becomes subject to an administration order or (being an individual or firm) becomes bankrupt or (being a company) goes into liquidation (otherwise than for the purpose of amalgamation or reconstruction); or

11.1.2 an encumbrancer takes possession or a receiver is appointed of any of the property or assets of the Buyer; or

11.1.3 the Buyer ceases or threatens to cease to carry on business; or

11.1.4 the Company reasonably apprehends that any of the events mentioned above is about to occur in relation to the Buyer and notifies the Buyer accordingly.

11.2 If this clause applies then without prejudice to any other right or remedy available to the Company the Company shall be entitled to cancel the Contract or suspend any further deliveries under the contract without any liability to the Buyer and if the Goods have been delivered but not paid for the price shall become immediately due and payable notwithstanding any previous agreement or arrangement to the contrary.

## 12. Liability

12.1 The Company shall not be liable to the Buyer or be deemed to be in breach of any obligation by reason of any delay or failure in performing any obligations in relation to the goods if delay or failure was due to any cause beyond the Company's reasonable control and without prejudice to the generality of the foregoing the following shall be regarded as such causes.

12.1.1 Act of God, explosion, flood, tempest, fire or accident

12.1.2 War or threat of war, sabotage insurrection, civil disturbance or requisition.

12.1.3 Acts, restrictions, bye-laws, prohibitions or measures of any kind on the part of any governmental, parliamentary or local authority.

12.1.4 Import or export regulations, embargoes, strikes, lock-outs or other industrial actions or trade disputes (whether involving employees of the Company or of a third party).

## 13 Import licences

Where applicable the Seller will be responsible for obtaining an import licence and for ensuring compliance with all regulation governing the admission of the goods into the country for delivery.

## 14 Governing law

Any contract between us and the Buyer shall be governed in all respects by the Laws of England. The Buyer shall submit to a jurisdiction of the English Courts.

## 15 Notices

Where a notice is required to be served on us by the Buyer, or on the Buyer by us such notice must be served in writing. Any notice to us shall be sent to us at our Registered Office and any notice to the Buyer shall be sent to the Buyer at the address given by the Buyer in his order or acceptance of our offer. Where in these Conditions a period is specified within which notice is to be given such notice must reach the party to which it is addressed within that period.

## 16 Forbearance

No forbearance or indulgence by the Seller shown or granted to the Buyer whatsoever in respect of these Terms or otherwise shall in any way affect or prejudice the rights of the Seller or to be taken as a waiver of any of these terms.

# History

## Brandenburg Direct

Brandenburg is the World's leading manufacturer of professional Flying Insect Control Systems.

Located in the West Midlands in the UK, Brandenburg is a leading manufacturer of professional insect control systems, and has been at the forefront of fly control technology since 1962. Using its in-house design skills coupled with high technology manufacturing processes Brandenburg are able to supply the best insect control systems available in the market place. The company employs Engineering, Manufacturing and Sales & Marketing based around the world to provide its customers with local support and its stakeholders a long-term future based on ethical business practices.

Our range of innovative and technically advanced products has established a global reputation that empowers customers to be leaders in their chosen markets. As the leaders in this field of flying insect control systems, we will continue to provide world class quality, service and commitment well into the future

# Brandenburg

Direct Ltd.



For more information about Brandenburg Direct contact:

**Andrew Coates**  
Sales Manager  
T: 07792 069 015  
E: [andrewcoates@b-one.com](mailto:andrewcoates@b-one.com)

**Richard Coates**  
Managing Director  
T: 07970 406 797  
E: [richardcoates@b-one.com](mailto:richardcoates@b-one.com)

Brandenburg Direct Ltd, 29 Navigation Drive, Hurst Business Park, Brierley Hill, West Midlands DY5 1UT  
T: 01384 472 907  
[www.b-one.com](http://www.b-one.com)



# History

## History Of Huck Nets (UK)

Huck Nets [UK] Limited is based in Bridport Dorset, a thriving market town that since the 13th century has been renowned for net, twine and rope making. In fact, even much earlier, in Roman times, the hemp and flax that was used for making rope had been grown in the area. Such was the fame of Bridport rope that it was used for making the hangman's nooses, which became known as the Bridport Dagger. To be 'stabbed by a Bridport dagger' was to be hung at the gallows!

It was in 1211 when King John, planning the war with France, demanded large supplies of hempen thread for ships and cables that the town's rope industry developed. King John ordered the Sheriff of Dorset to get the people of Bridport to work day and night to make ropes for the admiralty's sea fleet.

Bridport and its nearby harbour at West Bay reached their peak of prosperity in the 18th and 19th century, corresponding with Britain's sea power in the age of sail. Nets were traditionally made by hand and as a result many families in the area were involved in making nets from home. For more than 700 years Bridport has been at the forefront of net-making technology and the town still has a prospering net industry.

Huck Nets [UK] Limited was set up in Bridport in 1996 and is part of the Huck Group of Companies, founded by Manfred Huck in Germany in 1963. Starting as a one man business based in his garage in Berghausen, today Huck Nets is an international operation selling its product through Huck agencies and branches worldwide. Sadly Manfred Huck died in 1999 at the age of 63 years; the company is now managed by his son, Stefan Huck.

Huck Nets has built a reputation for its technological advances and in particular for pioneering knotless netting which is stronger and easier to handle than traditional knotted netting. Knotless netting forms the basis of the majority of Huck's rope products which includes, sports nets, industrial nets, safety nets for building sites, playground equipment comprising nets and ropes and nets for bird and pest control.

**As well as manufacturing and supplying net products, Huck Nets [UK] offers a full installation service.**

**Huck Nets [UK] occupies 48,000 sq ft of factory space, employs 43 people across sales, production and installation, and has a turnover in excess of £6M.**



For more information about Huck Nets contact:

**Dave Collins**  
 Manager - Bird Control Solutions  
 T: 01308 425100  
 E: dave.collins@hucknetting.co.uk

**Jon Legg-Bagg**  
 Managing Director  
 T: 01308 425100  
 E: jon@hucknetting.co.uk







**HUCK** *Bird Control*

Bird Control Division Sales & Service

**Tel: 01308 425100**

Fax: 01308 458109

Email: [dave.collins@hucknetting.co.uk](mailto:dave.collins@hucknetting.co.uk)

**[www.huck-net.co.uk](http://www.huck-net.co.uk)**